

SNOWSOUND

Acoustics & Wellbeing technologies

Caimi

SNOWCUSTOM

Caimi Lab

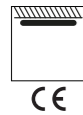

A+E optional
Info pag. 22



Clicca e vai alla
pagina selezionata.

Click and go to the
selected page.

I Pannelli fonoassorbenti brevettati realizzati in fibre di poliestere a densità variabile rivestiti in tessuto Snowsound Fiber, disponibili nella versione a parete e a soffitto. L'ampia gamma di dimensioni e finiture consente di adattarsi alle diverse esigenze estetiche e architettoniche.

EN Both wall and ceiling versions are available of these sound-absorbing panels, which are made of variable-density polyester fibres covered in Snowsound Fiber. A wide range of sizes and finishes means these panels can cater to different aesthetic and architectural needs.

F Panneaux phono-absorbants brevetés réalisés en fibres de polyester à densité variable revêtus en tissu Snowsound Fiber, disponibles dans la version pour paroi et pour plafond. Le vaste assortiment des dimensions et finitions permet de s'adapter aux différentes exigences esthétiques et architecturales.

D Schallabsorbierende patentierte Paneele aus Polyesterfasern mit variabler Dichte, bezogen mit Snowsound Fiber, erhältlich als Wand- und Deckenversion. Die große Auswahl an Größen und Ausführungen ermöglicht die Anpassung an unterschiedliche ästhetische und bauliche Anforderungen.

E Paneles fonoabsorbentes de fibras de poliéster de densidad variable, tapizados con el tejido Snowsound Fiber. Están disponibles en la versión de pared y de techo. Su amplia gama de medidas y acabados les permite adaptarse a cualquier tipo de demanda estética y arquitectónica.



Fiber 3 Melange



Fiber 8 Bouclé



Fiber 0







I_La tecnologia Snowcustom consente di realizzare pannelli fonoassorbenti su misura per adattare le scelte di correzione acustica alle diverse esigenze estetiche e architettoniche dei progetti.

EN _Snowcustom technology allows sound-absorbing panels to be customized in order to meet specific acoustic, aesthetic and architectural requirements in every project.

F_La technologie Snowcustom permet de réaliser des panneaux phono-absorbants sur mesure pour adapter les mesures de correction acoustique aux différentes exigences esthétiques et architecturales du projet.

D_Die Snowcustom-Technologie ermöglicht es, schallabsorbierende Paneele nach Maß zu erstellen, um die akustische Korrektur an die verschiedenen ästhetischen und baulichen Anforderungen des jeweiligen Projekts anzupassen.

E_La tecnología Snowcustom permite realizar paneles fonoabsorbentes a medida para poder adaptar la corrección acústica a las diversas necesidades estéticas y arquitectónicas de cada proyecto.



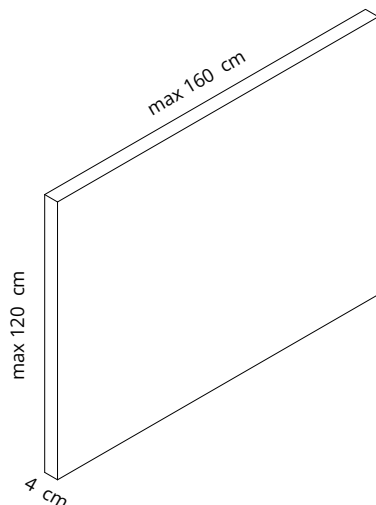

Pannello con imbottitura interna in poliester a densità variabile, rivestimento esterno in tessuto Snowsound-Fiber Textiles 0, 3 Melange, 8 Bouclé. Tempi di consegna 4/5 settimane (mese di agosto escluso).

- tolleranza sulle dimensioni ± 3 mm

PER DIMENSIONI, FORME E COLORI NON COMPRESI IN QUESTO LISTINO PREZZI, CONTATTATE IL NOSTRO UFFICIO COMMERCIALE.

Per composizioni che prevedono l'utilizzo di forme, dimensioni e/o materiali diversi tra loro, contattare l'ufficio commerciale

N.B. lo spessore dei pannelli Snowcustom è ora di 4 cm. Per completamenti di composizioni già installate, contattare il nostro ufficio commerciale

CONDIZIONI COMMERCIALI

- Considerata la lavorazione artigianale di Snowcustom, è richiesto un anticipo del 50% del valore al momento dell'ordine.

Panel with variable-density polyester internal padding, outer cover in Snowsound-Fiber Textiles 0, 3 Melange, 8 Bouclé. Lead time 4/5 weeks (month of August excluded).

- tolerance on dimensions ± 3 mm

FOR DIMENSIONS, SHAPES AND COLOURS NOT INCLUDED IN THIS PRICE LIST, PLEASE CONTACT OUR SALES DEPARTMENT.

For compositions using different shapes, sizes and/or materials, please contact the sales department. N.B. the thickness of Snowcustom panels is now 4 cm. For completions of already installed compositions, please contact our sales department.

SALES CONDITIONS

- Due to the handcrafted manufacture of Snowcustom, an advance payment of 50% of the value is required at the time of order.

Panneau avec rembourrage interne en polyester à densité variable, revêtement externe en tissu Snowsound-Fiber Textiles 0, 3 Melange, 8 Bouclé. Délai d'expédition 4/5 semaines (sauf le mois d'août).

- tolérance sur les dimensions ± 3 mm

POUR LES DIMENSIONS, FORMES ET COULEURS NE FIGURANT PAS DANS CETTE LISTE DE PRIX, VEUILLEZ CONTACTER NOTRE SERVICE COMMERCIAL.

Pour des compositions utilisant des formes, des tailles et/ou des matériaux différents, veuillez contacter le service commercial. N.B.

l'épaisseur des panneaux Snowcustom est désormais de 4 cm. Pour compléter des compositions déjà installées, veuillez contacter notre service commercial.

CONDITIONS COMMERCIALES

- En raison de la fabrication artisanale de Snowcustom, un acompte de 50 % de la valeur est demandé au moment de la commande.

Panel con acolchado interior de poliéster de densidad variable, revestimiento exterior en Snowsound-Fiber Textiles 0, 3 Melange, 8 Bouclé. Tiempos de entrega 4/5 semanas (mes de Agosto no incluido).

- tolerancia en las dimensiones ± 3 mm

PARA DIMENSIONES, FORMAS Y COLORES NO INCLUIDOS EN ESTA LISTA DE PRECIOS, PÓNGASE EN CONTACTO CON NUESTRO DEPARTAMENTO DE VENTAS.

Para composiciones con formas, tamaños y/o materiales diferentes, póngase en contacto con el departamento comercial. N.B. el grosor de los paneles Snowcustom es ahora de 4 cm. Para completar composiciones ya instaladas, póngase en contacto con nuestro departamento comercial.

CONDICIONES DE VENTA:

- Debido a la fabricación artesanal de Snowcustom, se requerirá un anticipo del 50% del total a la realización del pedido.

Paneel mit Polyester-Füllmaterial von unterschiedlicher Dichte, Außenbezug aus Snowsound-Fiber Textiles 0, 3 Melange, 8 Bouclé. Lieferzeit 4/5 Wochen (ausgenommen August).

- Toleranz bei den Abmessungen ± 3 mm

FÜR ABMESSUNGEN, FORMEN UND FARBEN, DIE NICHT IN DIESER PREISLISTE ENTHALTEN SIND, WENDEN SIE SICH BITTE AN UNSERE VERKAUFSABTEILUNG.

Für Kompositionen mit anderen Formen, Größen und/oder Materialien wenden Sie sich bitte an die Verkaufsabteilung. Die Dicke der Snowcustom Platten beträgt jetzt 4 cm. Für Ergänzungen von bereits installierten Kompositionen, kontaktieren Sie bitte unsere Verkaufsabteilung

VERKAUFSBEDINGUNGEN

- Da es sich bei den Snowcustom Vorhängen ausschließlich um Sonderanfertigungen gemäß Kundenvorgaben handelt, ist zum Zeitpunkt der Bestellung eine Anzahlung von 50 % des Warenwertes erforderlich.

- + 40% sul prezzo del pannello
- + 40% on panel price
- + 40 % sur le prix du panneau
- + 40% sobre el precio del panel
- + 40% auf den Panelpreis

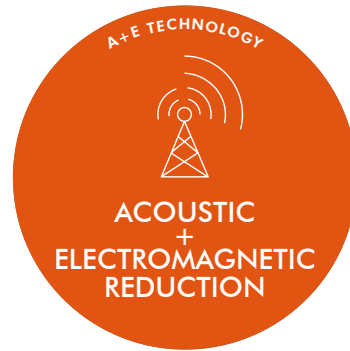

I pannelli Snowcustom possono essere forniti con tessuto riduttore di radiofrequenze. **Vedi pag. 22-23**

Snowcustom panles can be supplied with radio frequency reduction fabric. **See pages 22-23**

Les panneaux Snowcustom peuvent être fournis avec tissu réducteur des radiofréquences. **Voir pages 22-23**

Los panels Snowcustom pueden suministrarse con tejido reductor de radiofrecuencias. **Ver páginas 22-23**

Snowcustom Paneele können mit Radiofrequenz-Reduziergewebe geliefert werden. **Siehe Seiten 22-23**

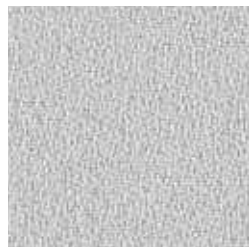
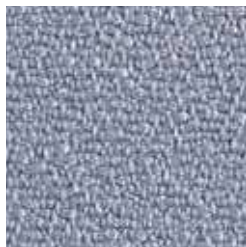

**COLORI DISPONIBILI
AVAILABLE COLORS****FIBER 0****8002****8004****8007****6046****7004****1008****COME ORDINARE:**

Scegliere il tipo di rivestimento **7SCF0 = SNOWCUSTOM FIBER 0**

Scegliere il colore per il tipo di rivestimento scelto (ad esempio, per Fiber 0: 8002)

Indicare le dimensioni L (lunghezza) e H (altezza), ad esempio 120x140

Il codice da ordinare sarà: **7SCF0-8002 120x140**

HOW TO ORDER:

Choose the type of covering **7SCF0 = SNOWCUSTOM FIBER 0**

Choose the colour for the chosen type of covering (e.g. for Fiber 0: 8002)

Indicate the dimensions L (length) and H (height), e.g. 120x140

The ordering code will be: **7SCF0-8002 120x140**

COMMENT COMMANDER:

Choisissez le type de revêtement **7SCF0 = SNOWCUSTOM FIBER 0**

Choisissez la couleur pour le type de revêtement choisi (ex. pour Fiber 0 : 8002)

Indiquez les dimensions L (longueur) et H (hauteur), ex. 120x140

Le code de commande sera: **7SCF0-8002 120x140**

CÓMO PEDIRLO:

Elija el tipo de revestimiento **7SCF0 = SNOWCUSTOM FIBER 0**

Elija el color para el tipo de revestimiento elegido (por ejemplo, para Fiber 0: 8002)

Indique las dimensiones L (longitud) y H (altura), por ejemplo 120x140

El código de pedido será: **7SCF0-8002 120x140**

BESTELLUNGSVORGANG:

Wählen Sie die Art des Belags **7SCF0 = SNOWCUSTOM FIBER 0**

Wählen Sie die Farbe für den gewählten Belagstyp (z.B. für Fiber 0: 8002)

Geben Sie die Abmessungen L (Länge) und H (Höhe) an, z.B. 120x140

Der Bestellcode lautet: **7SCF0-8002 120x140**

PER DIMENSIONI, FORME E COLORI NON COMPRESI IN QUESTO LISTINO PREZZI, CONTATTATE IL NOSTRO UFFICIO COMMERCIALE.

FOR DIMENSIONS, SHAPES AND COLOURS NOT INCLUDED IN THIS PRICE LIST, PLEASE CONTACT OUR SALES DEPARTMENT.

POUR LES DIMENSIONS, FORMES ET COULEURS NE FIGURANT PAS DANS CETTE LISTE DE PRIX, VEUILLEZ CONTACTER NOTRE SERVICE COMMERCIAL.

PARA DIMENSIONES, FORMAS Y COLORES NO INCLUIDOS EN ESTA LISTA DE PRECIOS, PÓNGASE EN CONTACTO CON NUESTRO DEPARTAMENTO DE VENTAS.

FÜR ABMESSUNGEN, FORMEN UND FARBEN, DIE NICHT IN DIESER PREISLISTE ENTHALTEN SIND, WENDEN SIE SICH BITTE AN UNSERE VERKAUFSABTEILUNG.

FIBER 0
7SCF0-XXXX

| cm | 40 | 50 | 60 | 70 | 80 | 90 | 100 | 110 | 120 | 130 | 140 | 150 | 160 |
|-----|----|----|----|----|----|----|-----|-----|-----|-----|-----|-----|-----|
| 40 | — | — | — | — | | | | | | | | | |
| 50 | — | — | — | — | | | | | | | | | |
| 60 | — | — | — | | | | | | | | | | |
| 70 | — | — | | | | | | | | | | | |
| 80 | | | | | | | | | | | | | |
| 90 | | | | | | | | | | | | | |
| 100 | | | | | | | | | | | | | |
| 110 | | | | | | | | | | | | | |
| 120 | | | | | | | | | | | | | |
| 130 | | | | | | | | | | — | — | — | — |
| 140 | | | | | | | | | | — | — | — | — |
| 150 | | | | | | | | | | — | — | — | — |
| 160 | | | | | | | | | | — | — | — | — |

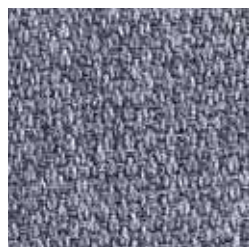
COLORI DISPONIBILI**AVAILABLE COLORS****FIBER 3 MELANGE**

300

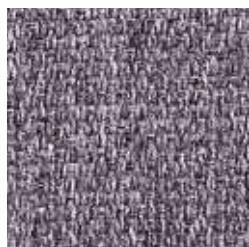

304



303



305



306



311



312

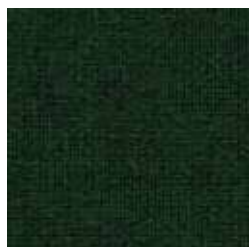

313



307



308



309



310



302



314



315



316

COME ORDINARE:Scegliere il tipo di rivestimento **7SCF3 = SNOWCUSTOM FIBER 3**

Scegliere il colore per il tipo di rivestimento scelto (ad esempio, per Fiber 3: 300)

Indicare le dimensioni L (lunghezza) e H (altezza), ad esempio 120x140

Il codice da ordinare sarà: **7SCF3-300 120x140****HOW TO ORDER:**Choose the type of covering **7SCF3 = SNOWCUSTOM FIBER 3**

Choose the colour for the chosen type of covering (e.g. for Fiber 3: 300)

Indicate the dimensions L (length) and H (height), e.g. 120x140

The ordering code will be: **7SCF3-300 120x140****COMMENT COMMANDER:**Choisissez le type de revêtement **7SCF3 = SNOWCUSTOM FIBER 3**

Choisissez la couleur pour le type de revêtement choisi (ex. pour Fiber 3: 300)

Indiquez les dimensions L (longueur) et H (hauteur), ex. 120x140

Le code de commande sera: **7SCF3-300 120x140****CÓMO PEDIRLO:**Elija el tipo de revestimiento **7SCF3 = SNOWCUSTOM FIBER 3**

Elija el color para el tipo de revestimiento elegido (por ejemplo, para Fiber 3: 300)

Indique las dimensiones L (longitud) y H (altura), por ejemplo 120x140

El código de pedido será: **7SCF3-300 120x140****BESTELLUNGSVORGANG:**Wählen Sie die Art des Belags **7SCF3 = SNOWCUSTOM FIBER 3**

Wählen Sie die Farbe für den gewählten Belagstyp (z.B. für Fiber 3: 300)

Geben Sie die Abmessungen L (Länge) und H (Höhe) an, z.B. 120x140

Der Bestellcode lautet: **7SCF3-300 120x140**

FIBER 3 MELANGE
7SCF3-XXX

| cm | 40 | 50 | 60 | 70 | 80 | 90 | 100 | 110 | 120 | 130 | 140 | 150 | 160 |
|-----|----|----|----|----|----|----|-----|-----|-----|-----|-----|-----|-----|
| 40 | — | — | — | — | | | | | | | | | |
| 50 | — | — | — | — | | | | | | | | | |
| 60 | — | — | — | | | | | | | | | | |
| 70 | — | — | | | | | | | | | | | |
| 80 | | | | | | | | | | | | | |
| 90 | | | | | | | | | | | | | |
| 100 | | | | | | | | | | | | | |
| 110 | | | | | | | | | | | | | |
| 120 | | | | | | | | | | | | | |
| 130 | | | | | | | | | | — | — | — | — |
| 140 | | | | | | | | | | — | — | — | — |
| 150 | | | | | | | | | | — | — | — | — |
| 160 | | | | | | | | | | — | — | — | — |

COLORI DISPONIBILI
AVAILABLE COLORS
FIBER 8 BOUCLE'

800

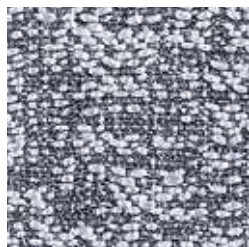

801



802



803

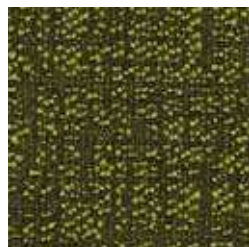

804



805

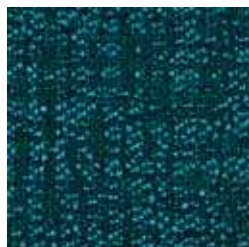

806



807



808

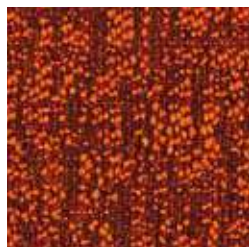

809



810



811



812



813



814



815

COME ORDINARE:Scegliere il tipo di rivestimento **7SCF8 = SNOWCUSTOM FIBER 8**

Scegliere il colore per il tipo di rivestimento scelto (ad esempio, per Fiber 8: 811)

Indicare le dimensioni L (lunghezza) e H (altezza), ad esempio 120x140

Il codice da ordinare sarà: **7SCF8-811 120x140****HOW TO ORDER:**Choose the type of covering **7SCF8 = SNOWCUSTOM FIBER 8**

Choose the colour for the chosen type of covering (e.g. for Fiber 8: 811)

Indicate the dimensions L (length) and H (height), e.g. 120x140

The ordering code will be: **7SCF8-811 120x140****COMMENT COMMANDER:**Choisissez le type de revêtement **7SCF8 = SNOWCUSTOM FIBER 8**

Choisissez la couleur pour le type de revêtement choisi (ex. pour Fiber 8: 811)

Indiquez les dimensions L (longueur) et H (hauteur), ex. 120x140

Le code de commande sera: **7SCF8-811 120x140****CÓMO PEDIRLO:**Elija el tipo de revestimiento **7SCF8 = SNOWCUSTOM FIBER 8**

Elija el color para el tipo de revestimiento elegido (por ejemplo, para Fiber 8: 811)

Indique las dimensiones L (longitud) y H (altura), por ejemplo 120x140

El código de pedido será: **7SCF8-811 120x140****BESTELLUNGSVORGANG:**Wählen Sie die Art des Belags **7SCF8 = SNOWCUSTOM FIBER 8**

Wählen Sie die Farbe für den gewählten Belagstyp (z.B. für Fiber 8: 811)

Geben Sie die Abmessungen L (Länge) und H (Höhe) an, z.B. 120x140

Der Bestellcode lautet: **7SCF8-811 120x140**

FIBER 8 BOUCLE'
7SCF8-XXX

| cm | 40 | 50 | 60 | 70 | 80 | 90 | 100 | 110 | 120 | 130 | 140 | 150 | 160 |
|-----|----|----|----|----|----|----|-----|-----|-----|-----|-----|-----|-----|
| 40 | — | — | — | — | | | | | | | | | |
| 50 | — | — | — | — | | | | | | | | | |
| 60 | — | — | — | | | | | | | | | | |
| 70 | — | — | | | | | | | | | | | |
| 80 | | | | | | | | | | | | | |
| 90 | | | | | | | | | | | | | |
| 100 | | | | | | | | | | | | | |
| 110 | | | | | | | | | | | | | |
| 120 | | | | | | | | | | | | | |
| 130 | | | | | | | | | | — | — | — | — |
| 140 | | | | | | | | | | — | — | — | — |
| 150 | | | | | | | | | | — | — | — | — |
| 160 | | | | | | | | | | — | — | — | — |

7S378/4

Kit 4 pcs.

Kit 4 attacchi magnetici a parete per pannelli Snowcustom (viti non incluse).

Kit of 4 magnetic wall mounts for Snowcustom panels (screws not included).

Kit de 4 supports muraux magnétiques pour les panneaux Snowcustom (vis non comprises).

Kit de 4 soportes magnéticos de pared para paneles Snowcustom (los tornillos no están incluidos).

Satz mit 4 magnetischen Wandhalterungen für Snowcustom-Panels (Schrauben nicht enthalten).

Pannelli vedi pag. / Panels see pages 219-221-223

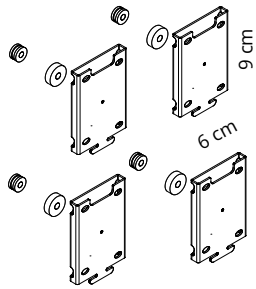

**4 pcs. = 1 code 7S378/4
per pannelli dimensioni fino a 80x80**

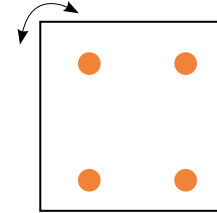
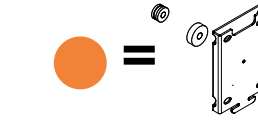

**Per pannelli dimensioni fino a 80x80 cm
For panel sizes up to 80x80 cm
Pour panneaux jusqu'à 80x80 cm
Para paneles de dimensiones hasta 80x80 cm
Für Plattengrößen bis zu 80x80**

7S378/6

Kit 6 pcs.

Kit 6 attacchi magnetici a parete per pannelli Snowcustom (viti non incluse).

Kit of 6 magnetic wall mounts for Snowcustom panels (screws not included).

Kit de 6 supports muraux magnétiques pour les panneaux Snowcustom (vis non comprises).

Kit de 6 soportes magnéticos de pared para paneles Snowcustom (los tornillos no están incluidos).

Satz mit 6 magnetischen Wandhalterungen für Snowcustom-Panels (Schrauben nicht enthalten).

Pannelli vedi pag. / Panels see pages 219-221-223

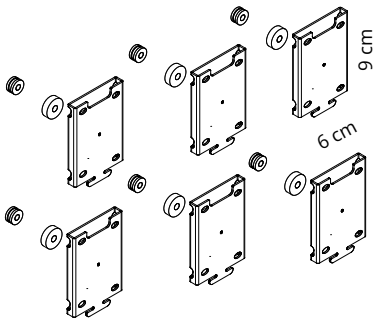

**6 pcs. = 1 code 7S378/6
per pannelli dimensioni da 80x90 a 120x160**

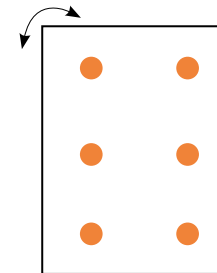
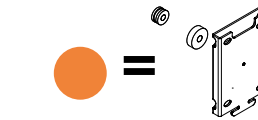

**Per pannelli dimensioni da 80x90 a 120x160 cm
For panel sizes from 80x90 to 120x160 cm
Pour panneaux de 80x90 à 120x160 cm
Para paneles de dimensiones 80x90 a 120x160 cm
Für Paneelgrößen von 80x90 bis 120x160 cm**

OPZIONALE OPTIONAL

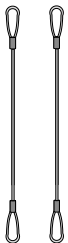

7W/A3

1 coppia / 1 pair
1 paire / 1 pare
1 Paar

Coppia di cavetti di sicurezza in acciaio.

Pair of steel safety cables.

Paire de câbles de sécurité en acier.

Par de cablecillos de seguridad de acero.

Ein Paar Sicherheitsseile aus Stahl.



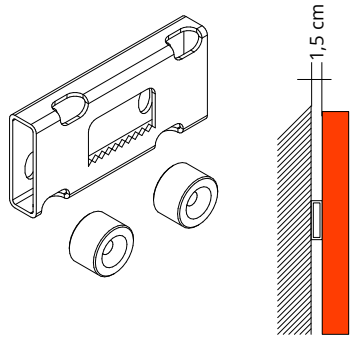

7S377

Attacco a parete in zamak verniciata per aggancio a chiodi/ganci, completo di 2 distanziali.

Painted zamak wall mount for nail/hook attachment, complete with 2 spacers.

Fixation murale en zamak peint pour fixation par clou ou crochet, complète avec 2 entretoises.

Fijación mural de zamak pintado para fijación clavo/gancho, completa con 2 distanciadores

Wandbefestigung aus lackiertem Zamak für Nagel-/Hakenbefestigung, komplett mit 2 Abstandshaltern

2 pcs. = 2 code 7S377
per tutte le dimensioni - for all dimensions

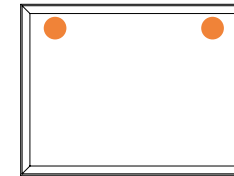
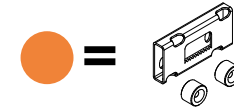

Utilizzare sempre 2 cod. 7S377
Always use 2 codes 7S377
Toujours utiliser 2 codes 7S377
Utilice siempre 2 cod. 7S377
Verwenden Sie immer 2 Code 7S377



FIBER 0



FIBER 3 MELANGE

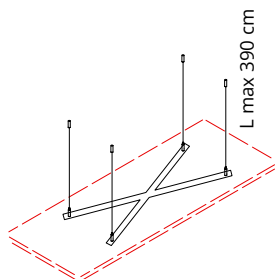

FIBER 8 BOUCLE'

**7INCF/1**

Struttura per fissaggio a soffitto per pannelli Snowcustom:
 Frame for Snowcustom panels ceiling fixing:
 Structure pour accrochage au plafond pour panneaux Snowcustom:
 Estructura para el montaje al techo para paneles Snowcustom:
 Rahmen für die Deckenbefestigung für Snowcustom Paneele:

**70x60 cm - 70x70 cm - 80x40 cm - 80x50 cm - 80x60 cm - 80x70 cm
 80x80 - 90x40 cm - 90x50 cm - 90x60 cm - 90x70 cm - 90x80 cm -
 90x90 cm - 40x100 cm - 50x100 cm - 60x100 cm**

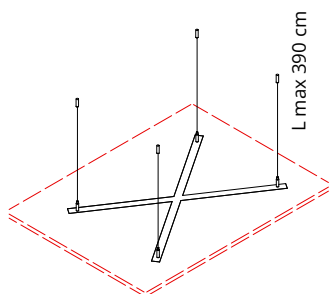
**7INCF/2**

Struttura per fissaggio a soffitto per pannelli Snowcustom:
 Frame for Snowcustom panels ceiling fixing:
 Structure pour accrochage au plafond pour panneaux Snowcustom:
 Estructura para el montaje al techo para paneles Snowcustom:
 Rahmen für die Deckenbefestigung für Snowcustom Paneele:

**70x100 cm - 80x100 cm - 90x100 cm - 100x100 cm - 40x110 cm
 50x110 cm - 60x110 cm - 70x110 cm - 80x110 cm - 90x110 cm -
 100x110 cm - 110x110 cm - 40x120 cm - 50x120 cm - 60x120 cm
 70x120 cm - 80x120 cm - 90x120 cm - 100x120 cm - 110x120 cm
 120x120 cm - 40x130 cm - 50x130 cm - 60x130 cm - 70x130 cm -
 80x130 cm - 90x130 cm - 100x130 cm - 110x130 cm - 120x130 cm
 40x140 cm - 50x140 cm - 60x140 cm - 70x140 cm**

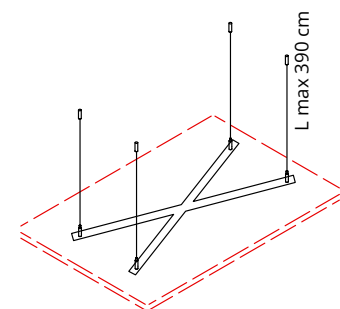
**7INCF/3**

Struttura per fissaggio a soffitto per pannelli Snowcustom:
 Frame for Snowcustom panels ceiling fixing:
 Structure pour accrochage au plafond pour panneaux Snowcustom:
 Estructura para el montaje al techo para paneles Snowcustom:
 Rahmen für die Deckenbefestigung für Snowcustom Paneele:

**80x140 cm - 90x140 cm - 100x140 cm - 110x140 cm - 120x140 cm -
 40x150 cm - 50x150 cm - 60x150 cm - 70x150 cm - 80x150 cm -
 90x150 cm - 100x150 cm - 110x150 cm - 120x150 cm - 40x160 cm
 50x160 cm - 60x160 cm - 70x160 cm - 80x160 cm - 90x160 cm -
 100x160 cm - 110x160 cm - 120x160 cm**



Deze informatie is afkomstig van de website van Zero-Z design / Akoestiekexpert.nl.

Voor vragen, toelichting en meer informatie kunt u contact opnemen met:

Zero-Z design

| | |
|------------------|-------------------|
| Jasmijnstraat 6a | Modem 20b |
| 3732 EC De Bilt | 7741 MJ Coevorden |

T +31 (0)30 2201297

F +31 (0)30 2210692

E info@zero-z-design.nl

W www.zero-z-design.nl

www.akoestiekexpert.nl

