

SNOWSOUND

Acoustics & Wellbeing technologies

Caimi

MILANO

Caimi Lab



I Paralume fonoassorbente di grandi dimensioni, realizzato con tessuto Snowsound Fiber 8 Bouclé, caratterizzato da una struttura in tubolare che tiene il tessuto acustico di rivestimento leggermente sciancrato all'esterno e plissettato all'interno. L'intercapedine d'aria che si crea tra il tessuto esterno e quello interno consente di incrementare le performance acustiche del paralume. Disponibile in due misure; diametro 80 e 120 cm. Il paralume è sospeso a soffitto mediante tre cavi regolabili in altezza.

EN Large sound-absorbing lampshade, made with Snowsound Fiber 8 Bouclé fabric, featuring a tubular structure that keeps the acoustic fabric slightly waisted on the outside and pleated on the inside. The air gap created between the external and internal fabric allows and increased acoustic performance of the lampshade. Available in two sizes; diameters 80 and 120 cm. The lampshade is suspended from the ceiling using three height-adjustable cables.

F Abat-jour phono-absorbant de grandes dimensions, réalisé avec le tissu Snowsound Fiber 8 Bouclé, caractérisé par une structure tubulaire qui maintient le tissu phono-absorbant légèrement détendu à l'extérieur et plissé à l'intérieur. L'espace d'air qui se crée entre le tissu externe et interne permet d'augmenter les performances acoustiques de l'abat-jour. Disponible en deux tailles; diamètre 80 et 120 cm. L'abat-jour est suspendu au plafond avec trois câbles à hauteur réglable.

D Großformatiger, schallabsorbierender Lampenschirm aus Snowsound Fiber 8 Bouclé-Gewebe, der sich durch eine röhrenförmige Struktur auszeichnet, die das akustische Bezugsmaterial auf der Außenseite leicht nach innen gewölbt und auf der Innenseite plissiert hält. Der Hohlraum, der zwischen der äußeren und der inneren Stofflage entsteht, verbessert die akustische Leistung des Lampenschirms. Erhältlich in zwei Größen: Durchmesser 80 und 120 cm. Der Lampenschirm wird mit drei höhenverstellbaren Seilen von der Decke abgehängt.

E Lámpara con pantalla fonoabsorbente de gran tamaño realizada con tejido Snowsound Fiber 8 Bouclé. Consta de una estructura tubular que hace que el tejido fonoabsorbente del revestimiento caiga, ciñéndose en la parte exterior y creando un plisado en la interior. El espacio que se crea entre el tejido externo y el interno permite aumentar sus prestaciones acústicas. Disponible en dos medidas: 80 o 120 cm de diámetro. La lámpara puede colgarse del techo mediante tres cables regulables en altura.







I_Il rivestimento in Snowsound Fiber 8 Bouclé è facilmente sfoderabile grazie alle zip che corrono lungo il perimetro superiore.

EN_The Snowsound Fiber 8 Bouclé covering is easily removable thanks to the zips that run along the upper perimeter.

F_Le revêtement en Snowsound Fiber 8 Bouclé s'enlève facilement grâce aux fermetures éclair le long du périmètre supérieur.

D_Der Bezug aus Snowsound Fiber 8 Bouclé ist dank der am oberen Rand verlaufenden Reißverschlüsse leicht abnehmbar.

E_El revestimiento de Snowsound Fiber 8 Bouclé es fácilmente desfundable gracias a las cremalleras ubicadas en el perímetro superior



I_Nel paralume possono essere utilizzati differenti corpi illuminanti.

EN_Different lighting elements can be used in the lampshade.

F_Différents luminaires peuvent être utilisés dans l'abat-jour.

D_Im Lampenschirm können verschiedene Leuchtkörper eingesetzt werden.

E_La lámpara con pantalla es compatible con diferentes cuerpos luminosos.



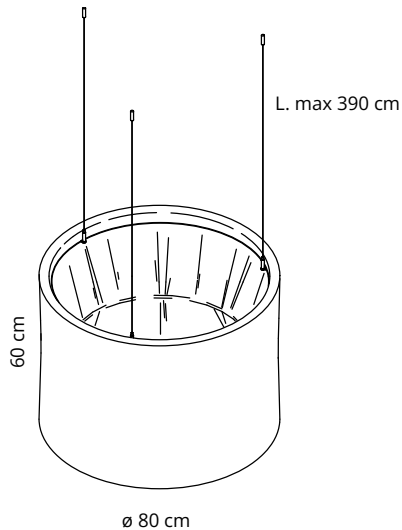

Colore
Colour
FIBER 8

Codice/Code

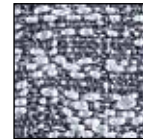

7MIL80-801



7MIL80-803

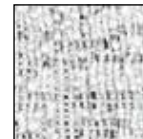

7MIL80-810



7MIL80-812



7MIL80-813

Elemento fonoassorbente con struttura in acciaio, telo fonoassorbente in poliestere **Snowsound-Fiber Textiles 8 Bouclé**. Tessuto asportabile e lavabile. Completo di kit per fissaggio a soffitto

Sound-absorbing element with steel frame, **Snowsound-Fiber Textiles 8 Bouclé** sound absorbing fabric. Removable and washable fabric. Equipped with Kit for the ceiling fixing.

Élément phono-absorbant avec structure en acier, toile phono-absorbante **Snowsound-Fiber Textiles 8 Bouclé**. Tissu amovible et lavable. Fourni avec kit d'accrochage au plafond.

Elemento fonoabsorbente con estructura de acero, tejido fonoabsorbente **Snowsound-Fiber Textiles 8 Bouclé**. Tejido extraíble y lavable. Completo de kit para el montaje al techo.

Schallabsorbierende Elemente mit Rahmen aus Stahl, Stoffbahn aus **Snowsound-Fiber Textiles 8 Bouclé** schallabsorbierendem Gewebe. Stoff abnehmbar und waschbar. Ausgestattet mit Set für die Deckenbefestigung.

Colori disponibili su richiesta / Colours available on request / Couleurs disponibles sur demande / Colores disponibles previa solicitud / Farben auf Anfrage erhältlich



800



802

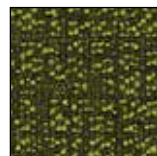

804



805

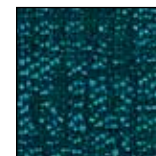

806



807

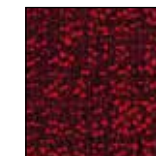

808

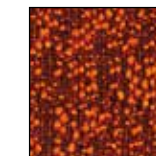

809



811

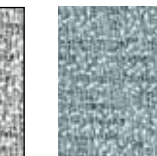

811

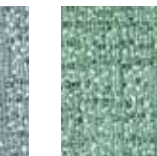

811

Minimo d'ordine per colore 5 pezzi / Minimum order quantity per colour 5 pieces / Quantité minimale par couleur 5 pièces / Pedido mínimo por color 5 unidades
Mindestbestellmenge pro Farbe 5 Stück

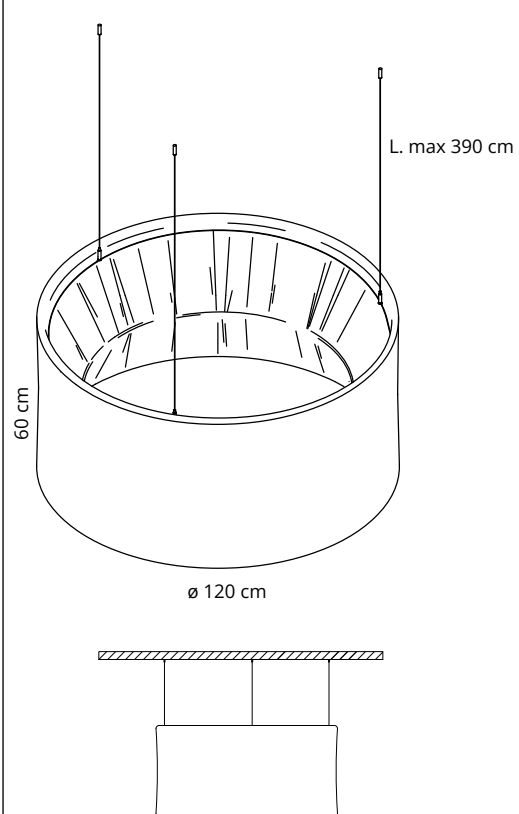

Colore / Colour

FIBER 8



7MIL120-801



7MIL120-803



7MIL120-810



7MIL120-812



7MIL120-813

Elemento fonoassorbente con struttura in acciaio, telo fonoassorbente in poliestere **Snowsound-Fiber Textiles 8 Bouclé**. Tessuto asportabile e lavabile. Completo di kit per fissaggio a soffitto

Sound-absorbing element with steel frame, **Snowsound-Fiber Textiles 8 Bouclé** sound absorbing fabric. Removable and washable fabric. Equipped with Kit for the ceiling fixing.

Élément phono-absorbant avec structure en acier, toile phono-absorbante **Snowsound-Fiber Textiles 8 Bouclé**. Tissu amovible et lavable. Fourni avec kit d'accrochage au plafond.

Elemento fonoabsorbente con estructura de acero, tejido fonoabsorbente **Snowsound-Fiber Textiles 8 Bouclé**. Tejido extraíble y lavable. Completo de kit para el montaje al techo.

Schallabsorbierende Elemente mit Rahmen aus Stahl, Stoffbahn aus **Snowsound-Fiber Textiles 8 Bouclé** schallabsorbierendem Gewebe. Stoff abnehmbar und waschbar. Ausgestattet mit Set für die Deckenbefestigung.

Colori disponibili su richiesta / Colours available on request / Couleurs disponibles sur demande / Colores disponibles previa solicitud / Farben auf Anfrage erhältlich



800



802

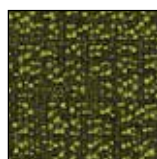

804



805

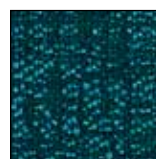

806



807

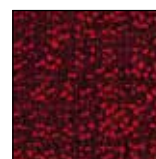

808

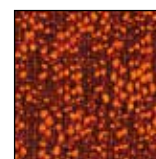

809



811



811



811

Minimo d'ordine per colore 5 pezzi / Minimum order quantity per colour 5 pieces / Quantité minimale par couleur 5 pièces / Pedido mínimo por color 5 unidades
Mindestbestellmenge pro Farbe 5 Stück

LED 40W

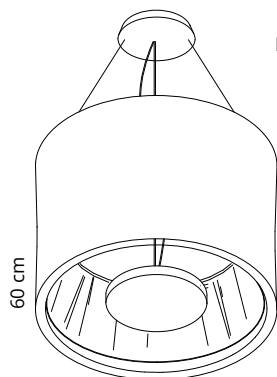

L. max 300 cm

60 cm

ø 80 cm

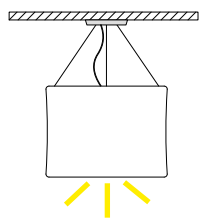
Colore
Colour
FIBER 8

Codice/Code



7MIL80L-801



7MIL80L-803



7MIL80L-810



7MIL80L-812

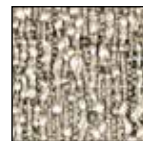

7MIL80L-813

Elemento fonoassorbente con struttura in acciaio, telo fonoassorbente in poliesteri **Snowsound-Fiber Textiles 8 Bouclé**. Tessuto asportabile e lavabile. Completo di kit per fissaggio a soffitto. Con lampada LED 40W, 3000K. La lampada è regolabile in altezza all'interno del paralume per ottenere l'illuminazione desiderata.

Sound-absorbing element with steel frame, **Snowsound-Fiber Textiles 8 Bouclé** sound absorbing fabric. Removable and washable fabric. Equipped with Kit for the ceiling fixing. With LED lamp 40W, 3000K. The lamp is height-adjustable within the shade to achieve the desired illumination.

Élément phono-absorbant avec structure en acier, toile phono-absorbante **Snowsound-Fiber Textiles 8 Bouclé**. Tissu amovible et lavable. Fourni avec kit d'accrochage au plafond. Avec lampe LED 40W, 3000K. La lampe est réglable en hauteur à l'intérieur de l'abat-jour afin d'obtenir l'éclairage souhaité.

Elemento fonoassorbente con estructura de acero, tejido fonoabsorbente **Snowsound-Fiber Textiles 8 Bouclé**. Tejido extraíble y lavable. Completo de kit para el montaje al techo. Con lámpara LED 40W, 3000K. La lámpara es regulable en altura dentro de la pantalla para conseguir la iluminación deseada.

Schallabsorbierende Elemente mit Rahmen aus Stahl, Stoffbahn aus **Snowsound-Fiber Textiles 8 Bouclé** schallabsorbierendem Gewebe. Stoff abnehmbar und waschbar. Ausgestattet mit Set für die Deckenbefestigung. Mit LED-Lampe 40W, 3000K. Die Lampe ist innerhalb des Schirms höhenverstellbar, um die gewünschte Beleuchtungsstärke zu erreichen.

Colori disponibili su richiesta / Colours available on request / Couleurs disponibles sur demande / Colores disponibles previa solicitud / Farben auf Anfrage erhältlich



800



802

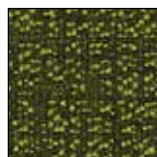

804



805

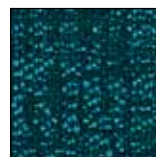

806



807

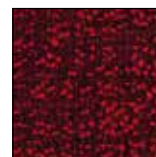

808

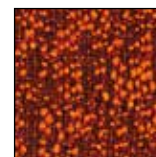

809



811



811



811

Minimo d'ordine per colore 5 pezzi / Minimum order quantity per colour 5 pieces / Quantité minimale par couleur 5 pièces / Pedido mínimo por color 5 unidades
Mindestbestellmenge pro Farbe 5 Stück

LED 40W

Colore / Colour / Codice/Code

FIBER 8

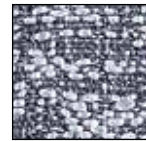

7MIL120L-801

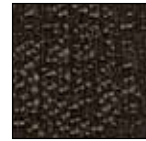

7MIL120L-803

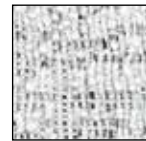

7MIL120L-810



7MIL120L-812



7MIL120L-813

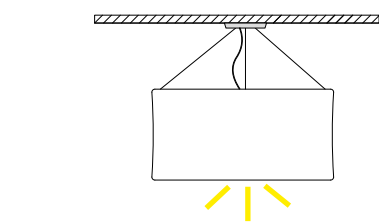
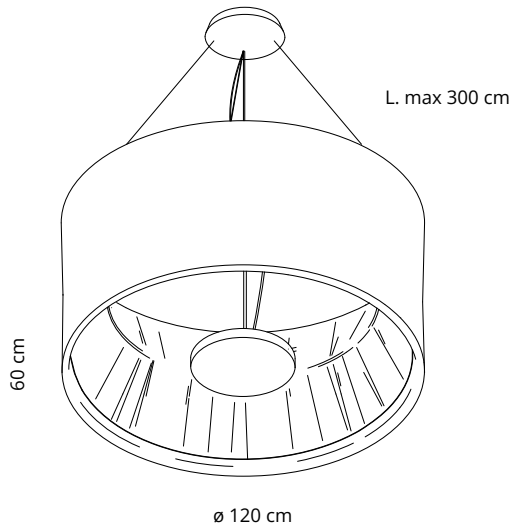

Elemento fonoassorbente con struttura in acciaio, telo fonoassorbente in poliesteri **Snowsound-Fiber Textiles 8 Bouclé**. Tessuto asportabile e lavabile. Completo di kit per fissaggio a soffitto. Con lampada LED 40W, 3000K. La lampada è regolabile in altezza all'interno del paralume per ottenere l'illuminazione desiderata.

Sound-absorbing element with steel frame, **Snowsound-Fiber Textiles 8 Bouclé** sound absorbing fabric. Removable and washable fabric. Equipped with Kit for the ceiling fixing. With LED lamp 40W, 3000K. The lamp is height-adjustable within the shade to achieve the desired illumination.

Élément phono-absorbant avec structure en acier, toile phono-absorbante **Snowsound-Fiber Textiles 8 Bouclé**. Tissu amovible et lavable. Fourni avec kit d'accrochage au plafond. Avec lampe LED 40W, 3000K. La lampe est réglable en hauteur à l'intérieur de l'abat-jour afin d'obtenir l'éclairage souhaité.

Elemento fonoabsorbente con estructura de acero, tejido fonoabsorbente **Snowsound-Fiber Textiles 8 Bouclé**. Tejido extraíble y lavable. Completo de kit para el montaje al techo. Con lámpara LED 40W, 3000K. La lámpara es regulable en altura dentro de la pantalla para conseguir la iluminación deseada.

Schallabsorbierende Elemente mit Rahmen aus Stahl, Stoffbahn aus **Snowsound-Fiber Textiles 8 Bouclé** schallabsorbierendem Gewebe. Stoff abnehmbar und waschbar. Ausgestattet mit Set für die Deckenbefestigung. Mit LED-Lampe 40W, 3000K. Die Lampe ist innerhalb des Schirms höhenverstellbar, um die gewünschte Beleuchtungsstärke zu erreichen.

Colori disponibili su richiesta / Colours available on request / Couleurs disponibles sur demande / Colores disponibles previa solicitud / Farben auf Anfrage erhältlich



800 802 804 805 806 807 808 809 811 811 811

Minimo d'ordine per colore 5 pezzi / Minimum order quantity per colour 5 pieces / Quantité minimale par couleur 5 pièces / Pedido mínimo por color 5 unidades
Mindestbestellmenge pro Farbe 5 Stück

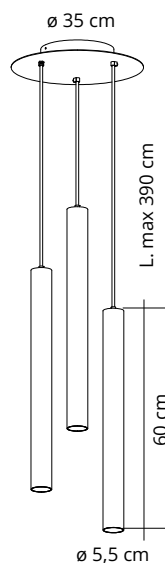
**7LGH15-BO**

Apparecchio di illuminazione a sospensione fornito di 3 sorgenti luminose a LED ciascuna da 10W, 3000K, con accensione unica. Corpi illuminanti realizzati in alluminio verniciato e dotati di cavo di alimentazione con lunghezza modificabile (L. max. 390 cm) per posizionare le lampade ad altezze differenti. Le sorgenti luminose arretrate garantiscono un comfort visivo ottimale. Per codici 7CLR873-XXX - 7CLR8203-XXX - 7MIL80-XXX - 7MIL120-XXX.

Suspended lighting fixture with 3 LED lights with 10W output, 3000K and single switch. Light fixture made of painted aluminium, with a length-adjustable power cable (max. extension 390 cm) for setting luminaires at different heights. The recessed light sources offer optimal visual comfort. For codes 7CLR873-XXX - 7CLR8203-XXX - 7MIL80-XXX - 7MIL120-XXX.

Appareil d'éclairage à suspension fourni avec 3 sources lumineuses à LED de 10W chacune, 3000K, avec allumage unique. Les corps lumineux sont en aluminium peint et équipés d'un câble d'alimentation d'une longueur modifiable (L. Max 390 cm) pour positionner les lampes à des hauteurs différentes. Les sources lumineuses en retrait assurent un confort visuel optimal. Pour art. 7CLR873-XXX - 7CLR8203-XXX - 7MIL80-XXX - 7MIL120-XXX.

Aparato de iluminación colgante, que viene con 3 fuentes de luz de LED (de 10W cada una, 3000K, con encendido único). Los cuerpos de iluminación de aluminio pintado constan de un cable de alimentación, cuyo largo se puede modificar (L. máx. 390 cm) para ubicar las lámparas a alturas diferentes. Las fuentes de luz desplazadas hacia atrás garantizan un confort visual excelente. Para códigos 7CLR873-XXX - 7CLR8203-XXX - 7MIL80-XXX - 7MIL120-XXX.

Hängeleuchte mit 3 LED-Lichtquellen, jede zu 10W, 3000K mit gleichzeitiger Einschaltung. Die Leuchtkörper sind aus lackiertem Aluminium gefertigt und mit einem längenverstellbaren Stromkabel (L. max. 390 cm) ausgestattet, um die Lampen in verschiedenen Höhen zu positionieren. Die versenkten Lichtquellen sorgen für optimalen Sichtkomfort. Für Art. 7CLR873-XXX - 7CLR8203-XXX - 7MIL80-XXX - 7MIL120-XXX.

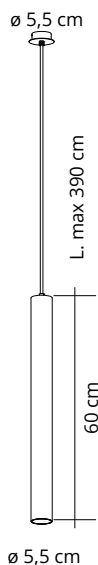
**7LGH16-BO**

Apparecchio di illuminazione a sospensione con sorgente luminosa a LED da 10W, 3000K. Corpo illuminante realizzato in alluminio verniciato e dotato di cavo di alimentazione con lunghezza modificabile (L. max. 390 cm). Le sorgenti luminose arretrate garantiscono un comfort visivo ottimale. Per codici 7CLR873-XXX - 7CLR8203-XXX - 7MIL80-XXX - 7MIL120-XXX.

Suspended lighting fixture with 1 LED light with 10W output, 3000K. Light fixture made of painted aluminium, with a length-adjustable power cable (max. extension 390 cm) The recessed light sources offer optimal visual comfort. For codes 7CLR873-XXX - 7CLR8203-XXX - 7MIL80-XXX - 7MIL120-XXX.

Appareil d'éclairage à suspension fourni avec 1 source lumineuse à LED de 10W, 3000K. Le corp lumineux est en aluminium peint et équipés d'un câble d'alimentation d'une longueur modifiable (L. Max 390 cm). Les sources lumineuses en retrait assurent un confort visuel optimal. Pour art. 7CLR873-XXX - 7CLR8203-XXX - 7MIL80-XXX - 7MIL120-XXX.

Aparato de iluminación colgante, que viene con 1 fuente de luz de LED (de 10W, 3000K). El cuerpo de iluminación de aluminio pintado consta de un cable de alimentación, cuyo largo se puede modificar (L. máx. 390 cm). Las fuentes de luz desplazadas hacia atrás garantizan un confort visual excelente. Para códigos 7CLR873-XXX - 7CLR8203-XXX - 7MIL80-XXX - 7MIL120-XXX.

Hängeleuchte mit 1 LED-Lichtquellen, jede zu 10W, 3000K. Die Leuchtkörper sind aus lackiertem Aluminium gefertigt und mit einem längenverstellbaren Stromkabel (L. max. 390 cm) ausgestattet. Die versenkten Lichtquellen sorgen für optimalen Sichtkomfort. Für Art. 7CLR873-XXX - 7CLR8203-XXX - 7MIL80-XXX - 7MIL120-XXX.

LED 40W

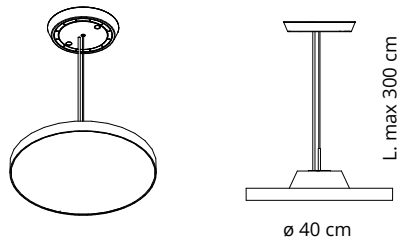

7LGH12-BO

Apparecchio di illuminazione a sospensione con sorgente luminosa a LED da 40W, 3000K. Struttura in metallo dotata di cavo regolabile in altezza. Cavo di alimentazione L. 300 cm. Per art. 7CLR873-XXX - 7CLR8203-XXX - 7MIL80-XXX - 7MIL120-XXX.

Suspended lighting fixture with 40W LED source, 3000K. Metal structure with with height-adjustable cable. Power cable L. 300 cm. For codes 7CLR873-XXX - 7CLR8203-XXX - 7MIL80-XXX - 7MIL120-XXX.

Appareil d'éclairage à suspension avec source de lumière à LED de 40W, 3000K. La structure en metal est munie d'un câble réglable en hauteur. Câble d'alimentation L. 300 cm. Pour art. 7CLR873-XXX - 7CLR8203-XXX - 7MIL80-XXX - 7MIL120-XXX.

Aparato de iluminación colgante con fuente de luz de LED de 40 W, 3000K. Estructura de metal, con cable regulable en altura. Cable de alimentación de 300 cm de largo. Para códigos 7CLR873-XXX - 7CLR8203-XXX - 7MIL80-XXX - 7MIL120-XXX.

Hängeleuchte mit 40W LED-Lichtquelle, 3000K. Struktur aus Metall mit höhenverstellbarem Seil. Stromversorgungskabel L. 300 cm. Für Art. 7CLR873-XXX - 7CLR8203-XXX - 7MIL80-XXX - 7MIL120-XXX.

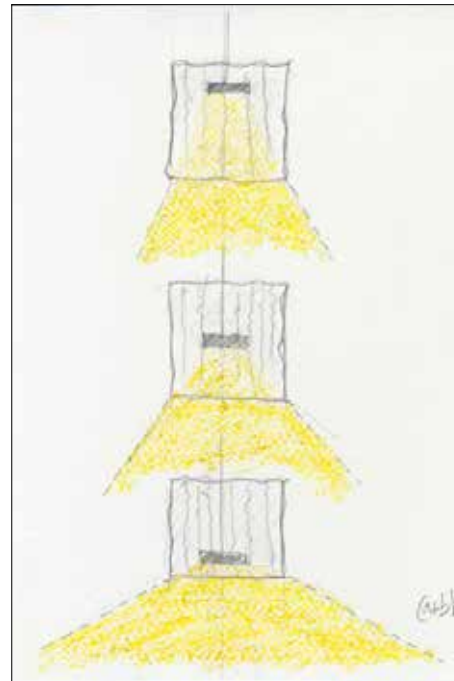

Deze informatie is afkomstig van de website van Zero-Z design / Akoestiekexpert.nl.

Voor vragen, toelichting en meer informatie kunt u contact opnemen met:

Zero-Z design

Jasmijnstraat 6a	Modem 20b
3732 EC De Bilt	7741 MJ Coevorden

T +31 (0)30 2201297

F +31 (0)30 2210692

E info@zero-z-design.nl

W www.zero-z-design.nl

www.akoestiekexpert.nl

