

**SNOWSOUND**

Acoustics & Wellbeing technologies

**Caimi**

# MITESCO

## Michele De Lucchi

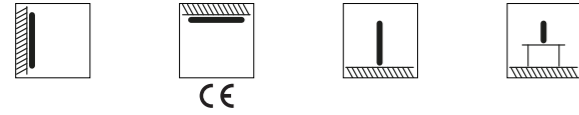

**I**\_"La questione dell'acustica è molto complessa e per risolverla c'è bisogno di soluzioni estremamente semplici e non invasive. Il progetto sviluppato con Caimi è un pannello acustico che ha la dote di essere realizzato in un unico materiale, il poliestere, che alle ottime qualità di assorbimento aggiunge il fatto di essere completamente riciclabile, non avendo inclusioni di altri materiali. Il prodotto è leggero, colorato e sufficientemente "basic" da essere utilizzato anche per personalizzare l'ambiente, essendo inseribile appieno nei contesti contemporanei."

**EN**\_"The issue of acoustics is very complex, extremely simple and non-invasive solutions are needed to resolve it. The project developed with Caimi is an acoustic panel that is made with one single material, polyester, which in addition to its excellent absorbent qualities is completely recyclable, as it does not contain any other materials. Mitesco is light, colourful and sufficiently basic to be used even to personalize the surrounding area, as it can be fully inserted in a contemporary context."

**F**\_"La question de l'acoustique est très complexe et afin de la résoudre il faut des solutions extrêmement simples et non invasives. Le projet développé par Caimi est un panneau acoustique fait avec un seul matériel, le polyester, qui juxtapose aux excellentes qualités d'absorption le fait d'être entièrement recyclable, compte tenu qu'aucun autre matériel n'est prévu. Le produit est léger, coloré et suffisamment de base afin de l'utiliser pour personnaliser toute ambiance, compte tenu qu'il peut être utilisé pour meubler toute ambiance."

**D**\_"Das Thema Akustik ist sehr komplex, umso mehr bedarf es einfacher und unkomplizierter Lösungen. Das mit Caimi entwickelte Projekt ist ein akustisches Panel, das nur aus einem einzigen Material, Polyester, besteht, und sich daher neben seiner hervorragenden akustischen Eigenschaften dadurch auszeichnet, dass es komplett recyclebar ist. Das Produkt ist leicht, farbenfroh und unkompliziert genug um sogar zur individuellen Gestaltung der Umgebung verwendet zu werden, da es sich völlig in einen zeitgemäßen Kontext einfügt."

**E**\_"La cuestión de la acústica es muy compleja y para resolverla se necesitan soluciones muy simples y no invasivas. El proyecto desarrollado con Caimi es un panel acústico que tiene la dote de estar realizado con un único material, el poliéster, que a las óptimas características de absorción acústica añade el hecho de ser completamente reciclable, al no incluir otros materiales. El producto es liviano, de color y suficientemente "basic" para ser utilizado también para personalizar el ambiente, encajando perfectamente en los contextos contemporáneos."

(Michele De Lucchi)

Medtronic Italia, Milano (Italy)



## Mitesco magnetic

**I**\_Gli attacchi magnetici permettono, anche grazie alla leggerezza del pannello ed all'assenza di telai rigidi e spigolosi in alluminio o PVC (normalmente utilizzati in similari dispositivi fonoassorbenti), di applicare e di rimuovere facilmente i pannelli.

**EN**\_Magnetic connections make it easy to quickly apply or remove the panels. This is possible thanks to the lightness of the panel and the absence of rigid, sharp-edged aluminum/PVC frames (normally adopted in similar acoustic devices).

**F**\_Les connexions magnétiques permettent, grâce à la légèreté du panneau et à l'absence de cadres rigides ou coupants en aluminium ou en PVC (généralement utilisés pour des dispositifs similaires phono-absorbants), de fixer et enlever aisément les panneaux.

**D**\_Dank der Leichtigkeit des Paneels sowie dem Verzicht auf starre und kantige Rahmen aus Aluminium oder PVC (die normalerweise bei ähnlichen akustischen Elementen verwendet werden) ermöglichen die Magnetbefestigungen es, die Paneele einfach anzubringen und abzunehmen.

**E**\_Los enganches magnéticos permiten, también gracias a la liviandad del panel y al no tener bastidores rígidos y angulosos de aluminio o PVC (normalmente utilizados en dispositivos fonoabsorbentes similares), aplicar y remover fácilmente los paneles.



Technical Center (Japan)



## Mitesco wall | ceiling

**I**\_Il pannello fonoassorbente Mitesco è dotato di supporti che ne permettono il fissaggio a parete/soffitto. Il pannello fonoassorbente Mitesco può anche essere agganciato a chiodi/viti fissati nelle pareti mediante un gancio.

**EN**\_The sound-absorbing Mitesco panels has supports that allow it to be anchored to wall/ceiling. Mitesco sound-absorbing panels can be held in place by nails or screws anchored to walls with a hook.

**F**\_Le panneau phono-absorbant Mitesco est muni de supports qui permettent de le fixer aux paroi/plafond. Le panneau phono-absorbant Mitesco peut également être fixé à des clous ou à des vis fixés dans les murs, grâce à un crochet.







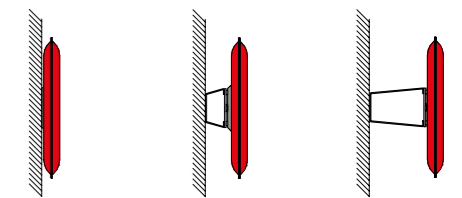
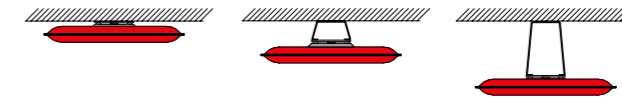

**D**\_Das schallabsorbierende Paneel Mitesco weist Halterungen auf, dank derer man es direkt an der Wand/Decke kann. Das schallabsorbierende Paneel Mitesco kann auch mit Hilfe eines Hakens durch Nägel oder Schrauben an der Wand befestigt werden.

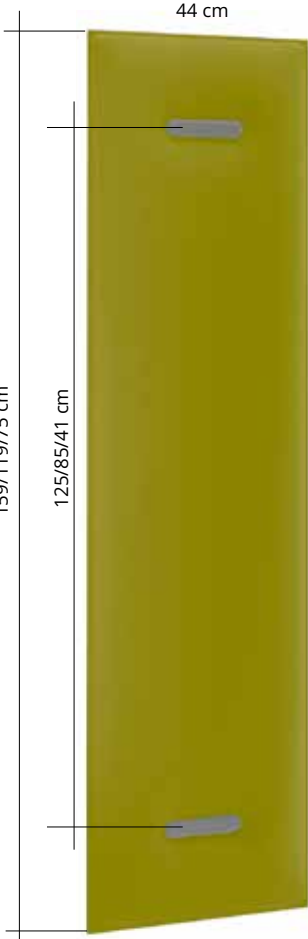
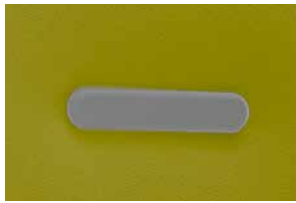
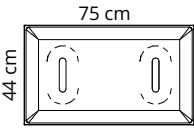
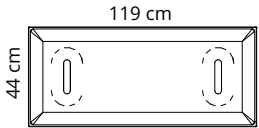
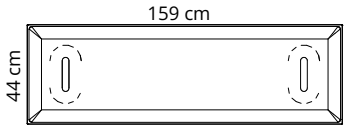







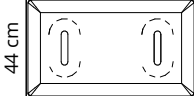

**E**\_El panel fonoabsorbente Mitesco lleva soportes para fijación mural/techo. El panel fonoabsorbente Mitesco también se puede anclar, mediante un gancho, a clavos/tornillos clavados en las paredes.



AXA Assicurazioni, Milano (Italy)



  Copertura grigia / Grey cover Couverture gris / Cobertura gris / Graue Abdeckung	Copertura grigia Grey cover Couverture gris Cobertura gris Graue Abdeckung	Colore Colour	75 cm 	119 cm 	159 cm 
			Codice/Code Prezzo/Price	Codice/Code Prezzo/Price	Codice/Code Prezzo/Price
 Bianco White Blanc	0001	7M1008-0001	7M1012-0001	7M1016-0001	
 Grigio argento Silver grey Gris argenté	8004	7M1008-8004	7M1012-8004	7M1016-8004	
 Grigio scuro Dark grey Gris foncté	8007	7M1008-8007	7M1012-8007	7M1016-8007	
 Beige Beige Beige	1008	7M1008-1008	7M1012-1008	7M1016-1008	
 Rosso Red Rouge	4027	7M1008-4027	7M1012-4027	7M1016-4027	
 Verde chiaro Light green Vert clair	7004	7M1008-7004	7M1012-7004	7M1016-7004	
 Blu Blue Bleu	6071	7M1008-6071	7M1012-6071	7M1016-6071	

	<p><b>Copertura bianca</b> <b>White cover</b> <b>Couverture blanche</b> <b>Cobertura blanca</b> <b>Weisse Abdeckung</b></p> <p>Colore Colour</p>	75 cm	119 cm	159 cm
				
		Codice/Code Prezzo/Price	Codice/Code Prezzo/Price	Codice/Code Prezzo/Price
 <p><b>Copertura bianca / White cover</b> <b>Couverture blanche / Cobertura blanca / Weisse Abdeckung</b></p>	 <p>Bianco White Blanc</p> <p><b>0001</b></p>	<b>7M1008BO-0001</b>	<b>7M1012BO-0001</b>	<b>7M1016BO-0001</b>
	 <p>Grigio argento Silver grey Gris argenté</p> <p><b>8004</b></p>	<b>7M1008BO-8004</b>	<b>7M1012BO-8004</b>	<b>7M1016BO-8004</b>
	 <p>Grigio scuro Dark grey Gris foncté</p> <p><b>8007</b></p>	<b>7M1008BO-8007</b>	<b>7M1012BO-8007</b>	<b>7M1016BO-8007</b>
	 <p>Beige Beige Beige</p> <p><b>1008</b></p>	<b>7M1008BO-1008</b>	<b>7M1012BO-1008</b>	<b>7M1016BO-1008</b>
	 <p>Rosso Red Rouge</p> <p><b>4027</b></p>	<b>7M1008BO-4027</b>	<b>7M1012BO-4027</b>	<b>7M1016BO-4027</b>
	 <p>Verde chiaro Light green Vert clair</p> <p><b>7004</b></p>	<b>7M1008BO-7004</b>	<b>7M1012BO-7004</b>	<b>7M1016BO-7004</b>
	 <p>Blu Blue Bleu</p> <p><b>6071</b></p>	<b>7M1008BO-6071</b>	<b>7M1012BO-6071</b>	<b>7M1016BO-6071</b>

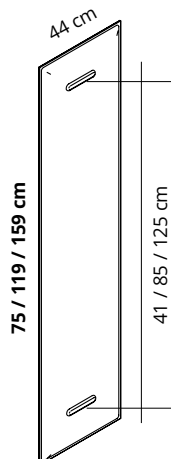

Pannello con imbottitura interna in poliester a **densità variabile** Snowsound® Technology. Rivestimento esterno in tessuto di poliester Trevira CS®.

Completo di attacchi in tecnopolimero e acciaio e coperture frontali in tecnopolimero grigio o bianco.

Il pannello può essere fissato direttamente a parete tramite viti (non incluse). Peso del singolo pannello 2,7 / 2,3 / 1,5 Kg.

Panel with polyester internal padding with Snowsound® Technology **variable density**. Polyester covering in Trevira CS® fabric.

Supplied with connections in high-tech polymer and steel and grey or white high-tech polymer front covers.

The panel can be directly fixed to the wall through screws (not included).

Weight of single panel: 2,7 / 2,3 / 1,5 kg

Panneau avec rembourrage interne en polyester à **densité variable** Snowsound® Technology. Revêtement externe en tissu de polyester Trevira CS®.

Avec jonctions en technopolymère et acier et couvertures frontales en technopolymère gris ou blanc. On peut fixer le panneau directement au mur par des vis (pas incluses). Poids d'un panneau: 2,7 / 2,3 / 1,5 kg

Panel con acolchado interior de poliéster de **densidad variable** Snowsound® Technology. Revestimiento exterior de tejido de poliéster Trevira CS®. Incluye enganches de polímero y acero y coberturas frontales de polímero gris o blanco. El panel puede ser fijado directamente a la pared por medio de tornillos (no incluydos). Peso para singular panel 2,7 / 2,3 / 1,5 Kg.

Panel mit Polyester-Füllmaterial von **unterschiedlicher Dichte** Snowsound® Technology. Polyester-Bezug aus Trevira CS®-Material. Inklusive Beschlägen aus Technopolymer und Stahl sowie grauen oder weissen Befestigungsabdeckungen aus Technopolymer. Das Paneel kann mit Schrauben (nicht inkludiert) direkt an der Wand montiert werden.

Gewicht eines Paneels: 2,7 / 2,3 / 1,5 kg.



Montaggio semplice  
a parete pannello  
Mitesco  
Basic wall mounting  
for Mitesco panel



Dettaglio attacco e copertura frontale colore grigio.

Detail of the connection and front cover. Grey Color.

Détail jonction et couverture frontale, couleur gris.

Detalle ataque y cobertura frontal color gris.

Detaildarstellung der Befestigungsbeschläge und grauer Abdeckung



Dettaglio attacco e copertura frontale colore bianco.

Detail of the connection and front cover. White Color.

Détail jonction et couverture frontale, couleur blanc.

Detalle ataque y cobertura frontal color blanco.

Detaildarstellung der Befestigungsbeschläge und weisser Abdeckung

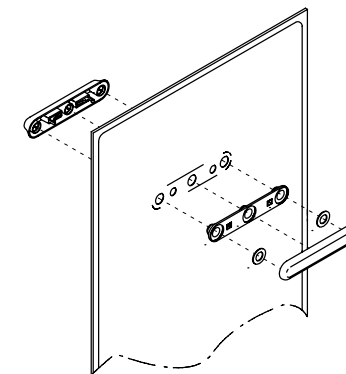

Dettaglio dell'attacco con copertura frontale forniti di serie in colore grigio o bianco.

Le coperture frontali sono disponibili anche colorate cod. 7M102-XXXX (XXXX = Variante colore).

Detail of the connection and front cover in standard grey or white. The front covers are also available in other colors with code 7M102-XXXX (XXXX = Color option).

Détail de la jonction avec couverture frontale, fournie standard en couleur gris ou blanc. Les couvertures frontales sont disponibles aussi dans d'autres couleurs avec réf. 7M102-XXXX (XXXX = option couleur).

Detalle ataque con cobertura frontal incluye en color gris o blanco. Las coberturas frontales son disponibles también en color cod. 7M102-XXXX (XXXX = Variante color).

Detaildarstellung der Befestigungsbeschläge mit standardmäßiger Abdeckung in grau oder weiss. Die Abdeckungen sind auch in anderen Farben erhältlich, Art. 7M102-XXXX (XXXX = Farbvariante).

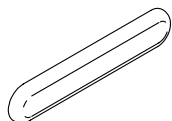

**7M102-0001**

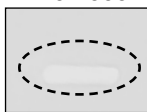

Bianco  
White  
Blanc  
Weiss  
Blanco

1 coppia / 1 pair  
1 paire / 1 pare  
1 Paar

**7M102-4027**

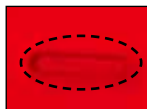

Rosso  
Red  
Rouge  
Rojo  
Rot

1 coppia / 1 pair  
1 paire / 1 pare  
1 Paar

Coppia di coperture frontali in tecnopolimero degli attacchi per 1 pannello Mitesco.

**OPZIONALE**

(Il pannello Mitesco è fornito di serie con le coperture frontali di colore grigio o bianco)

Pair of high-tech polymer front covers for connections for 1 panel Mitesco.

**OPTIONAL**

(Mitesco panels are supplied as standard with grey or white front covers)

Paire de couvertures frontales en technopolymère pour jonctions pour 1 panneau Mitesco.

**OPTIONNEL**

(Le panneau Mitesco est fourni en standard avec les couvertures frontales en couleur gris ou blanc)

Par de coberturas frontales de tecnopolimero para enganches de 1 panel Mitesco.

**OPCIONAL**

(el panel Mitesco ya incluye las coberturas frontales en color gris o blanco)

Paar Abdeckungen aus Technopolymer für Befestigung für 1 Paneel Mitesco.

**OPTIONAL erhältlich**

(Mitesco-Paneele werden standardmäßig mit grauen oder weissen Befestigungsabdeckungen geliefert).

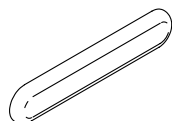

**7M102-8004**



Grigio argento  
Silver grey  
Gris argenté  
Gris plata  
Silbergrau

1 coppia / 1 pair  
1 paire / 1 pare  
1 Paar

**7M102-7004**

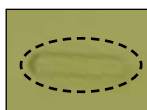

Verde chiaro  
Light green  
Vert clair  
Verde claro  
Hellgrün

1 coppia / 1 pair  
1 paire / 1 pare  
1 Paar

**7M102-8007**

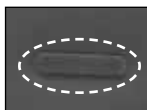

Grigio scuro  
Dark grey  
Gris foncé  
Gris oscuro  
Dunkelgrau

1 coppia / 1 pair  
1 paire / 1 pare  
1 Paar

**7M102-6071**



Blu  
Blue  
Bleu  
Azul  
Blau

1 coppia / 1 pair  
1 paire / 1 pare  
1 Paar

**7M102-1008**

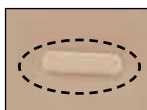

Beige  
Beige  
Beige  
Beige  
Beige

1 coppia / 1 pair  
1 paire / 1 pare  
1 Paar

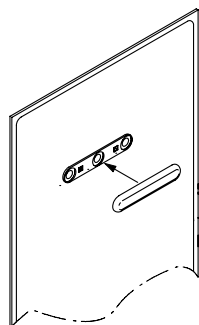

**NOTA**

Non utilizzare con staffe scrivania cod. 7M511-XX / 7M515-XX / 7M5100-XX / 7M519-XX / 7M518-XX / 7M517-XX (XX = Variante colore).

Not to be used with desk brackets code 7M511-XX / 7M515-XX / 7M5100-XX / 7M519-XX / 7M518-XX / 7M517-XX (XX = Color option).

Ne pas utiliser avec étriers pour bureau réf 7M511-XX / 7M515-XX / 7M5100-XX / 7M519-XX / 7M518-XX / 7M517-XX (XX = option couleur).

No utilizar con abrazaderas para mesa cod. 7M511-XX / 7M515-XX / 7M5100-XX / 7M519-XX / 7M518-XX / 7M517-XX (XX = Variante color).

Nicht zur Verwendung mit Halterungen für Tisch Art. 7M511-XX / 7M515-XX / 7M5100-XX / 7M519-XX / 7M518-XX / 7M517-XX (XX = Farbvariante).

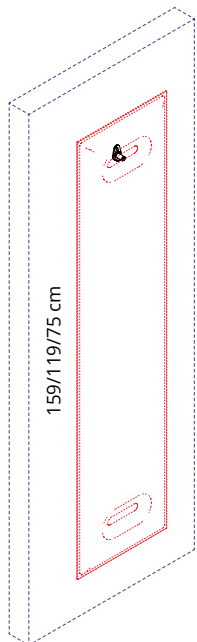

## 7M210-GR

Grigio  
Grey  
Gris  
Gris  
Grau

Aggancio semplice in tecnopolimero per fissaggio a parete tramite chiodo/vite (non inclusi) di un pannello Mitesco.

Easy connection in high-tech polymer for wall fixing by nail/screw (not included) of 1 Mitesco panel.

Accrochage simple en technopolymère pour fixation au mur par un clou/vis (pas inclus) d'un panneau Mitesco.

Enganche simple de polímero para fijación a pared por medio de clavo / tornillo (no incluido) de un panel Mitesco.

Einfache Befestigung aus Technopolymer für die Wandmontage mittels Nagel/Schraube (nicht inkludiert) eines Mitesco-Panels.

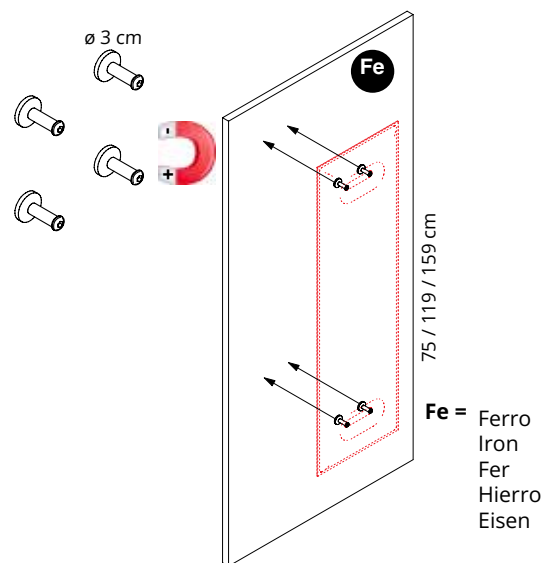

## 7M232

Kit 4 magneti per il fissaggio diretto ad una superficie verticale in ferro di un pannello Mitesco.

Set of 4 magnets for direct fixing to a vertical iron surface, of 1 Mitesco panel.

Jeu de 4 aimants pour la fixation directe à une surface verticale en fer d'un panneau Mitesco.

Kit de 4 imanes para la fijación directa à una superficie vertical de hierro de un panel Mitesco.

Set von 4 Magneten zur direkten Befestigung auf einer vertikal Eisenoberfläche, für 1 Mitesco-Paneel.



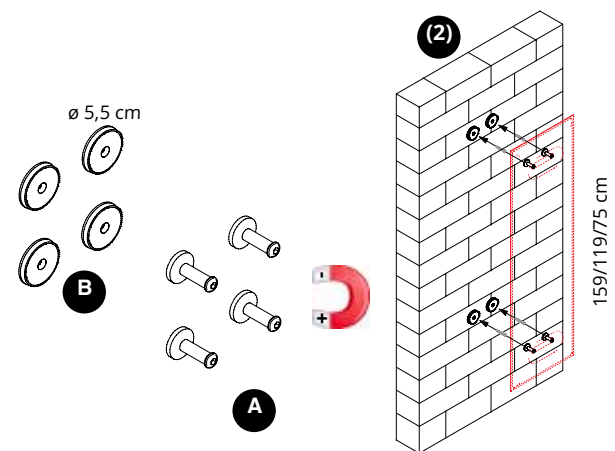
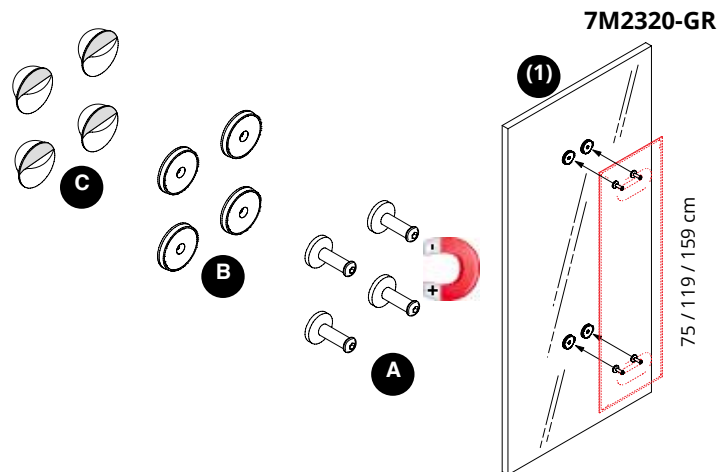

Kit per il fissaggio ad una superficie verticale in vetro o in muratura di un pannello Mitesco. Il kit è composto da: 4 magneti (A) / 4 dischi in acciaio e tecnopolimero grigio (B) / 4 dischi con biadesivo (C).

(1) Per le superfici in vetro applicare gli appositi dischetti con biadesivo (C).

(2) Per le superfici in muratura applicare direttamente i dischetti (B) tramite viti (non incluse)

Set for fixing to a glass or masonry vertical surface, of 1 Mitesco panel. Set composed of: 4 magnets (A) / 4 steel and high-tech polymer plates (B) / 4 plates with double-sided adhesive tape (C).

(1) For glass surfaces use the suitable plates with double-sided adhesive tape (C)

(2) For masonry surfaces fix directly the plates (B) with screws (not included)

Jeu pour fixation à une surface verticale en verre ou maçonnerie d'un panneau Mitesco. Le jeu se compose de: 4 aimants (A) / 4 disques en acier et technopolymère (B) / 4 disques avec bande biadhésive (C).

(1) Pour les surfaces en verre appliquer les disques par bande biadhésive (C)

(2) Pour les surfaces en maçonnerie appliquer directement les disques (B) par des vis (pas incluses)

Kit para fijación a una superficie vertical de vidrio o de mampostería de un panel Mitesco. Kit compuesto por: 4 imanes (A) / 4 discos de acero y polímero (B) / 4 discos con bi-adesivo (C).

(1) Para las superficies de vidrio aplicar los discos con su propio bi-adesivo (C)

(2) Para las superficies de mampostería aplicar directamente los discos (B) con tornillos (no incluidos)

Set zur Montage auf vertikal Glasoberflächen und Mauerwerk, für 1 Mitesco-Paneel. Set von: 4 Magneten (A) / 4 Scheiben aus Stahl und Technopolymer (B) / 4 doppelseitig klebende Scheiben (C).

(1) Für Glasoberflächen verwenden Sie die entsprechenden doppelseitig klebenden Scheiben (C)

(2) Für Mauerwerk befestigen Sie die Scheiben direkt (B) mit Schrauben (nicht inkludiert)

## MAGNETIC



7M2320-GR



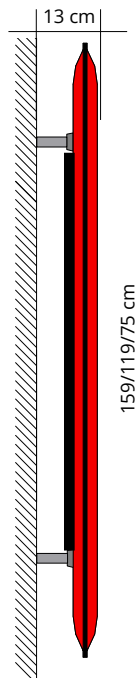
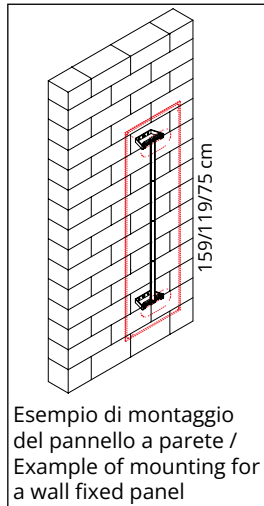
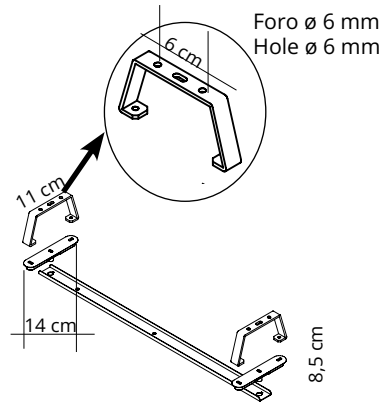

**7M2478-GA** Grigio argento  
 Silver grey  
 Gris argenté  
 Gris plata  
 Silbergrau

**Per pannelli**  
**For panels**  
**L. 75 cm**

Coppia attacchi distanziali in acciaio verniciato con polveri epossidiche e tecnopolimero per parete, completi di profilo livellatore per pannello Mitesco. Per montaggio a PARETE

**7M2472-GA** Grigio argento  
 Silver grey  
 Gris argenté  
 Gris plata  
 Silbergrau

**Per pannelli**  
**For panels**  
**L. 119 cm**

Pair of spacer connections in powder coated steel and high-tech polymer for wall, supplied with leveler profile for Mitesco panel. For WALL mounting

**7M2476-GA** Grigio argento  
 Silver grey  
 Gris argenté  
 Gris plata  
 Silbergrau

**Per pannelli**  
**For panels**  
**L. 159 cm**

Paire d'accrochages espaceurs en acier peint en époxy et technopolymère pour mur, avec un profil niveleur pour panneau Mitesco. Pour montage MURAL

Par de enganches espaciadores de acero recubierto epoxi y polímero para pared, incluye perfil nivelador para panel Mitesco. Para montaje en PARED

Paar Distanzhalterbefestigungen aus pulverbeschichtetem Stahl und Technopolymer zur Wandmontage, inkl. Justierungsprofil für Mitesco-Paneel. Für WANDMONTAGE

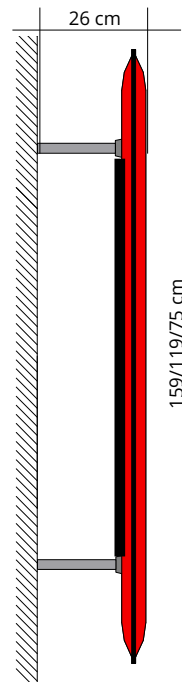
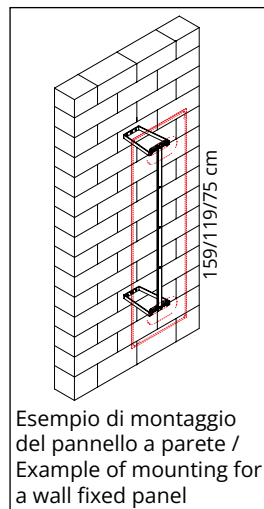
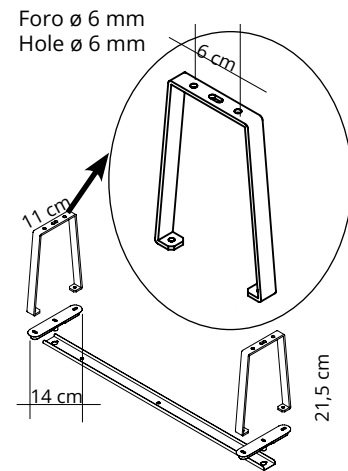

**7M2428-GA** Grigio argento  
 Silver grey  
 Gris argenté  
 Gris plata  
 Silbergrau

**Per pannelli**  
**For panels**  
**L. 75 cm**

Coppia attacchi distanziali in acciaio verniciato con polveri epossidiche e tecnopolimero per parete, completi di profilo livellatore per pannello Mitesco. Per montaggio a PARETE

**7M2422-GA** Grigio argento  
 Silver grey  
 Gris argenté  
 Gris plata  
 Silbergrau

**Per pannelli**  
**For panels**  
**L. 119 cm**

Pair of spacer connections in powder coated steel and high-tech polymer for wall, supplied with leveler profile for Mitesco panel. For WALL mounting

**7M2426-GA** Grigio argento  
 Silver grey  
 Gris argenté  
 Gris plata  
 Silbergrau

**Per pannelli**  
**For panels**  
**L. 159 cm**

Paire d'accrochages espaceurs en acier peint en époxy et technopolymère pour mur, avec un profil niveleur pour panneau Mitesco. Pour montage MURAL

Par de enganches espaciadores de acero recubierto epoxi y polímero para pared, incluye perfil nivelador para panel Mitesco. Para montaje en PARED

Paar Distanzhalterbefestigungen aus pulverbeschichtetem Stahl und Technopolymer zur Wandmontage, inkl. Justierungsprofil für Mitesco-Paneel. Für WANDMONTAGE



Deze informatie is afkomstig van de website van Zero-Z design / Akoestiekexpert.nl.

Voor vragen, toelichting en meer informatie kunt u contact opnemen met:

### **Zero-Z design**

Jasmijnstraat 6a | Modem 20b  
3732 EC De Bilt | 7741 MJ Coevorden

**T** +31 (0)30 2201297

**F** +31 (0)30 2210692

**E** [info@zero-z-design.nl](mailto:info@zero-z-design.nl)

**W** [www.zero-z-design.nl](http://www.zero-z-design.nl)

[www.akoestiekexpert.nl](http://www.akoestiekexpert.nl)

