

SNOWSOUND

MITESCO
PRODUCTOVERZICHT

Caimi
BREVETTI

PREMI AWARDS



International CES Innovations
Design and Engineering
Awards
(U.S.A.)



Best of NeoCon
(U.S.A.)



Product Innovation
Merit Award
(U.S.A.)



Trophée de l'Innovation
Bureaux Expo
(France)



Ho.Re.Ca.
Innovazione dell'anno
(Italy)



Gran Design Etico
International Award
Product: Miteco
(Italy)



Gran Design Etico
International Award
Product: Flap
(Italy)



German Design Award
Special Mention: Flap
(Germany)



German Design Award
Product: Miteco
(Germany)



ADI Design Index
Product: Flap
(Italy)

COLORI PANNELLI - PANELS' COLOURS COULEURS PANNEAUX - COLORES PANELES - PANELEE FARBEN

6071



Blu - Blue - Bleu - Azul - Blau

8033



Nero - Black - Noir - Negro -Schwarz

4027



Rosso - Red - Rouge - Rojo - Rot

8004

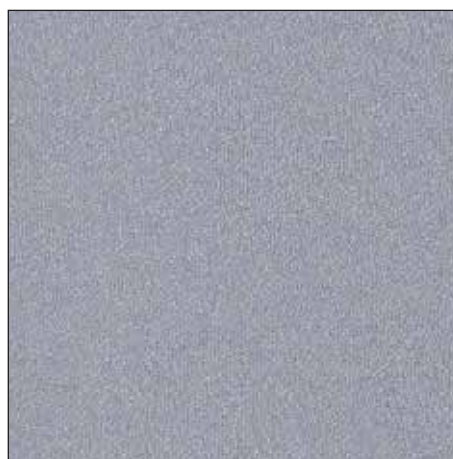

Grigio argento - Silver grey - Gris argenté -
Gris plata - Silbergrau

7013



Verde Mela - Apple green - Vert Pomme
Verde Manzana - Grüner Apfel

0001



Bianco - White - Blanc - Blanco - Weiss

8007

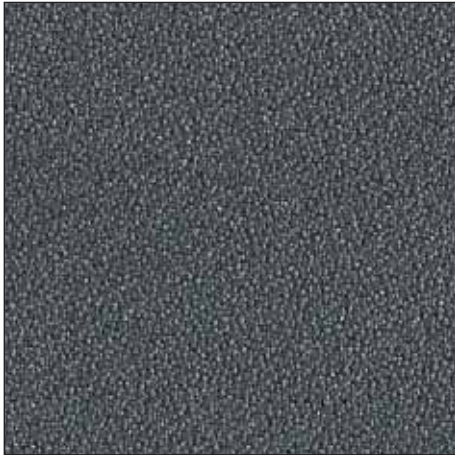

Grigio scuro - Dark grey - Gris foncé -
Gris oscuro - Dunkelgrau

4030

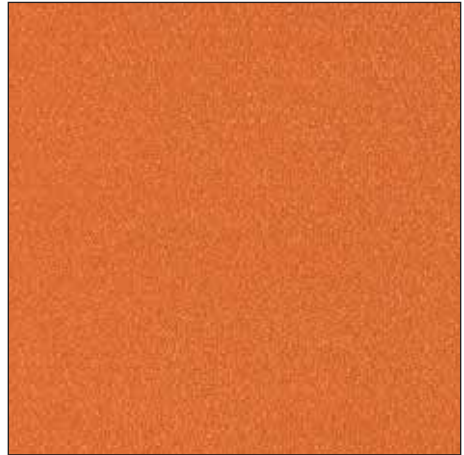

Arancione Carota - Carrot orange -
Orange Carotte - Anaranjado Zanahoria -
Orange Karotte

2005

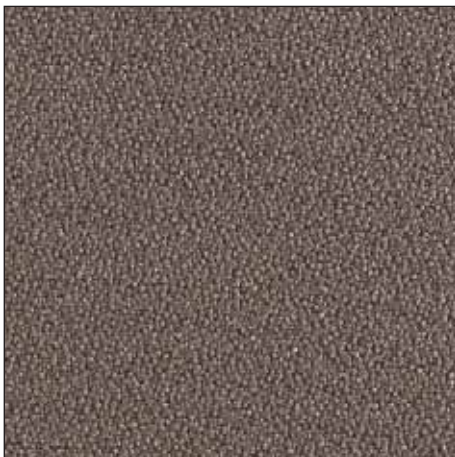

Tortora - Dove-grey - Taupe
Tórtola - Taubengrau

3008



Giallo Sole - Sun yellow - Jaune Soleil
Amarillo Sol - Gelbe Sonne

1008

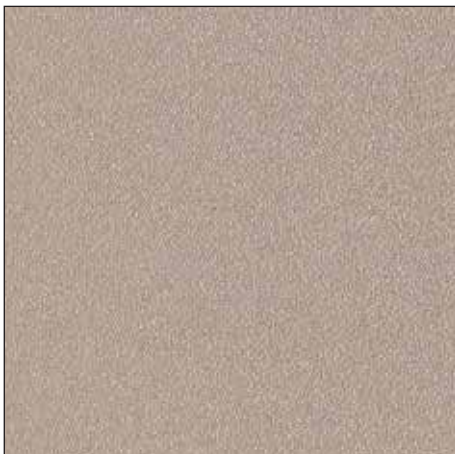

Beige - Beige - Beige - Beige - Beige

7004



Verde chiaro - Light green - Vert clair
Verde claro - Hellgrün

INDICE / INDEX



Mitiesco

page 8



Mitiesco Easy / Magnetic

page 14



Mitiesco Wall / Ceiling

page 16



Mitiesco Cables

page 18



Mitiesco Totem

page 22

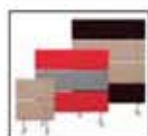

Mitiesco Divider

page 24

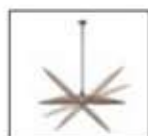

Mitiesco Ceiling

page 38



Mitiesco Frame

page 46



Mitiesco Net

page 50



Mitiesco Desk

page 56



Snowdesk

page 64

MITESCO 159/119/75x44 cm design Michele De Lucchi Snowsound® technology by Caimi Brevetti

Descrizione Description

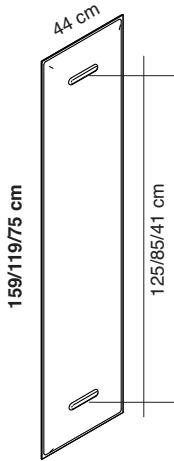

Pannello con imbottitura interna in poliester a **densità variabile** Snowsound® Technology. Rivestimento esterno in tessuto di poliester Trevira CS®.

Completo di attacchi in tecnopolimero e acciaio e coperture frontali in tecnopolimero grigio o bianco.

Il pannello può essere fissato direttamente a parete tramite viti (non incluse).

Il pannello può essere fissato direttamente anche a soffitto tramite viti (non incluse), utilizzando l'apposto profilo livellatore (non incluso) cod. 7M160-GA, per pannelli L. 159 cm, 7M120-GA, per pannelli L. 119 cm o 7M80-GA, per pannelli L. 75 cm.

Peso del singolo pannello 2,7 / 2,3 / 1,5 Kg.

Panel with polyester internal padding with Snowsound® Technology **variable density**. Polyester covering in Trevira CS® fabric. Supplied with connections in high-tech polymer and steel and grey or white high-tech polymer front covers.

The panel can be directly fixed to the wall through screws (not included).

The panel can be also fixed directly to the ceiling with screws (not included), by using the dedicated leveler profile (not included) cod. 7M160-GA, for panels L. 159 cm, 7M120-GA pr pannelli L. 119 cm or 7M80-GA, for panels L. 75 cm.

Weight of single panel: 2,7 / 2,3 / 1,5 kg

Panneau avec rembourrage interne en polyester à **densité variable** Snowsound® Technology. Revêtement externe en tissu de polyester Trevira CS®.

Avec jonctions en technopolymère et acier et couvertures frontales en technopolymère gris ou blanc.

On peut fixer le panneau directement au mur par des vis (pas incluses).

On peut aussi fixer le panneau directement au plafond par des vis (pas incluses) en utilisant le spécial profil niveleur (pas inclus) réf. 7M160-GA, pour panneaux L. 159 cm, 7M120-GA, pour panneaux L. 119 cm ou 7M80-GA, pour panneaux L. 75 cm.

Poids d'un panneau: 2,7 / 2,3 / 1,5 kg

Panel con acolchado interior de poliéster de **densidad variable** Snowsound® Technology. Revestimiento exterior de tejido de poliéster Trevira CS®.

Incluye enganches de polímero y acero y coberturas frontales de polímero gris o blanco.

El panel puede ser fijado directamente a la pared por medio de tornillos (no incluydos).

El panel puede ser tambien fijado directamente al techo por medio de tornillos (no incluydos) utilizando el correspondiente perfil nivelador (no incluydo) cod. 7M160-GA, por paneles L. 159 cm, 7M120-GA, por paneles L. 119 cm o 7M80-GA, por paneles L. 75 cm.

Peso para singulo panel 2,7 / 2,3 / 1,5 Kg.

Panel mit Polyester-Füllmaterial von **unterschiedlicher Dichte** Snowsound® Technology. Polyester-Bezug aus Trevira CS®-Material.

Inklusive Beschlägen aus Technopolymer und Stahl sowie grauen oder weissen Befestigungsabdeckungen aus Technopolymer.

Das Paneel kann mit Schrauben (nicht inkludiert) direkt an der Wand montiert werden.

Das Paneel kann auch unter Verwendung des Justierungsprofils Art. Nr. 7M160-GA, für Paneel L. 159 cm, 7M120-GA, für Paneel L. 119 cm oder 7M80-GA, für Paneel L. 75 cm (nicht inkludiert) mit Schrauben (nicht inkludiert) direkt an der Decke befestigt werden.

Gewicht eines Paneels: 2,7 / 2,3 / 1,5 kg.



Montaggio semplice a parete pannello Mitesco
Basic wall mounting for Mitesco panel

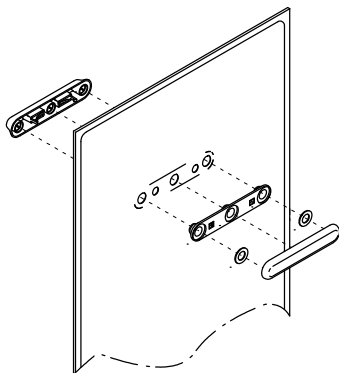

Dettaglio dell'attacco con copertura frontale forniti di serie in colore grigio o bianco. Le coperture frontali sono disponibili anche colorate cod. 7M102-XXXX (XXXX = Variante colore).

Detail of the connection and front cover in standard grey or white. The front covers are also available in other colours with code 7M102-XXXX (XXXX = colour option).

Détail de la jonction avec couverture frontale, fournie standard en couleur gris ou blanc. Les couvertures frontales sont disponibles aussi dans d'autres couleurs avec réf. 7M102-XXXX (XXXX = option couleur).

Detalle ataque con cobertura frontal incluyda en color gris o blanco. Las coberturas frontales son disponibles también en color cod. 7M102-XXXX (XXXX = Variante color).

Detaildarstellung der Befestigungsbeschläge mit standardmäßiger Abdeckung in grau oder weiss. Die Abdeckungen sind auch in anderen Farben erhältlich, Art. 7M102-XXXX (XXXX = Farbvariante).



Dettaglio attacco e copertura frontale colore grigio.

Detail of the connection and front cover. Grey colour.

Détail jonction et couverture frontale, couleur gris.



Detalle ataque y cobertura frontal color gris.

Detaildarstellung der Befestigungsbeschläge und grauer Abdeckung



Dettaglio attacco e copertura frontale colore bianco.

Detail of the connection and front cover. White colour.

Détail jonction et couverture frontale, couleur blanc.











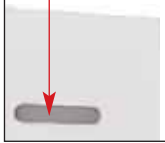



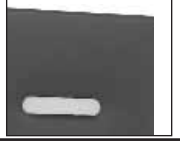









Detalle ataque y cobertura frontal color blanco.

Detaildarstellung der Befestigungsbeschläge und weisser Abdeckung



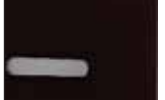







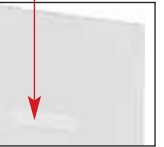

MITESCO 159x44 cm

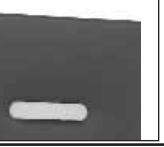
design Michele De Lucchi
Snowsound® technology by Caimi Brevetti

Copertura grigia Grey cover Couverture gris Cobertura gris Graue Abdeckung	Colore Colour	Codice Code	Prezzo Cad. Price each	Copertura bianca White cover Couverture blanche Cobertura blanca Weisse Abdeckung	Colore Colour	Codice Code	Prezzo Cad. Price each
	Bianco White Blanc 0001	7M1016-0001			Bianco White Blanc 0001	7M1016BO-0001	
	Grigio argento Silver grey Gris argenté 8004	7M1016-8004			Grigio argento Silver grey Gris argenté 8004	7M1016BO-8004	
	Grigio scuro Dark grey Gris foncté 8007	7M1016-8007			Grigio scuro Dark grey Gris foncté 8007	7M1016BO-8007	
	Beige Beige Beige 1008	7M1016-1008			Beige Beige Beige 1008	7M1016BO-1008	
	Tortora Dove-grey Taupe 2005	7M1016-2005			Tortora Dove-grey Taupe 2005	7M1016BO-2005	
	Giallo Yellow Jaune 3008	7M1016-3008			Giallo Yellow Jaune 3008	7M1016BO-3008	
	Arancione Orange Orange 4030	7M1016-4030			Arancione Orange Orange 4030	7M1016BO-4030	
	Rosso Red Rouge 4027	7M1016-4027			Rosso Red Rouge 4027	7M1016BO-4027	
	Verde chiaro Light green Vert clair 7004	7M1016-7004			Verde chiaro Light green Vert clair 7004	7M1016BO-7004	
	Verde Green Vert 7013	7M1016-7013			Verde Green Vert 7013	7M1016BO-7013	
	Blu Blue Bleu 6071	7M1016-6071			Blu Blue Bleu 6071	7M1016BO-6071	
	Nero Black Noir 8033	7M1016-8033			Nero Black Noir 8033	7M1016BO-8033	







MITESCO 119x44 cm

design Michele De Lucchi
Snowsound® technology by Caimi Brevetti

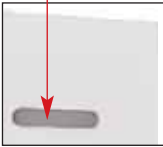
Copertura grigia Grey cover Couverture gris Cobertura gris Graue Abdeckung	Colore Colour	Codice Code	Prezzo Cad. Price each	Copertura bianca White cover Couverture blanche Cobertura blanca Weisse Abdeckung	Colore Colour	Codice Code	Prezzo Cad. Price each
	Bianco White Blanc 0001	7M1012-0001			Bianco White Blanc 0001	7M1012BO-0001	
	Grigio argento Silver grey Gris argenté 8004	7M1012-8004			Grigio argento Silver grey Gris argenté 8004	7M1012BO-8004	
	Grigio scuro Dark grey Gris foncé 8007	7M1012-8007			Grigio scuro Dark grey Gris foncé 8007	7M1012BO-8007	
	Beige Beige Beige 1008	7M1012-1008			Beige Beige Beige 1008	7M1012BO-1008	
	Tortora Dove-grey Taupe 2005	7M1012-2005			Tortora Dove-grey Taupe 2005	7M1012BO-2005	
	Giallo Yellow Jaune 3008	7M1012-3008			Giallo Yellow Jaune 3008	7M1012BO-3008	
	Arancione Orange Orange 4030	7M1012-4030			Arancione Orange Orange 4030	7M1012BO-4030	
	Rosso Red Rouge 4027	7M1012-4027			Rosso Red Rouge 4027	7M1012BO-4027	
	Verde chiaro Light green Vert clair 7004	7M1012-7004			Verde chiaro Light green Vert clair 7004	7M1012BO-7004	
	Verde Green Vert 7013	7M1012-7013			Verde Green Vert 7013	7M1012BO-7013	
	Blu Blue Bleu 6071	7M1012-6071			Blu Blue Bleu 6071	7M1012BO-6071	
	Nero Black Noir 8033	7M1012-8033			Nero Black Noir 8033	7M1012BO-8033	

MITESCO 75x44 cm

design Michele De Lucchi
Snowsound® technology by Caimi Brevetti

Copertura grigia Grey cover Couverture gris Cobertura gris Graue Abdeckung	Colore Colour	Codice Code	Prezzo Cad. Price each	Copertura bianca White cover Couverture blanche Cobertura blanca Weisse Abdeckung	Colore Colour	Codice Code	Prezzo Cad. Price each
	Bianco White Blanc 0001	7M1008-0001			Bianco White Blanc 0001	7M1008BO-0001	
	Grigio argento Silver grey Gris argenté 8004	7M1008-8004			Grigio argento Silver grey Gris argenté 8004	7M1008BO-8004	
	Grigio scuro Dark grey Gris foncté 8007	7M1008-8007			Grigio scuro Dark grey Gris foncté 8007	7M1008BO-8007	
	Beige Beige Beige 1008	7M1008-1008			Beige Beige Beige 1008	7M1008BO-1008	
	Tortora Dove-grey Taupe 2005	7M1008-2005			Tortora Dove-grey Taupe 2005	7M1008BO-2005	
	Giallo Yellow Jaune 3008	7M1008-3008			Giallo Yellow Jaune 3008	7M1008BO-3008	
	Arancione Orange Orange 4030	7M1008-4030			Arancione Orange Orange 4030	7M1008BO-4030	
	Rosso Red Rouge 4027	7M1008-4027			Rosso Red Rouge 4027	7M1016BO-4027	
	Verde chiaro Light green Vert clair 7004	7M1008-7004			Verde chiaro Light green Vert clair 7004	7M1008BO-7004	
	Verde Green Vert 7013	7M1008-7013			Verde Green Vert 7013	7M1008BO-7013	
	Blu Blue Bleu 6071	7M1008-6071			Blu Blue Bleu 6071	7M1008BO-6071	
	Nero Black Noir 8033	7M1008-8033			Nero Black Noir 8033	7M1008BO-8033	

Codice Code	Colore Colour	Prezzo Price	Descrizione Description
7M102-0001	Bianco White Blanc Weiss Blanco	1 coppia / 1 pair 1 paire / 1 pare 1 Paar	Coppia di coperture frontali in tecnopolimero degli attacchi per 1 pannello Mitesco. OPZIONALE (Il pannello Mitesco è fornito di serie con le coperture frontali di colore grigio o bianco)
7M102-8004	Grigio argento Silver grey Gris argenté Gris plata Silbergrau	1 coppia / 1 pair 1 paire / 1 pare 1 Paar	Pair of high-tech polymer front covers for connections for 1 panel Mitesco. OPTIONAL (Mitesco panels are supplied as standard with grey or white front covers)
7M102-8007	Grigio scuro Dark grey Gris foncé Gris oscuro Dunkelgrau	1 coppia / 1 pair 1 paire / 1 pare 1 Paar	Paire de couvertures frontales en technopolymère pour jonctions pour 1 panneau Mitesco. OPTIONNEL (Le panneau Mitesco est fourni en standard avec les couvertures frontales en couleur gris ou blanc)
7M102-1008	Beige Beige Beige Beige Beige	1 coppia / 1 pair 1 paire / 1 pare 1 Paar	Par de coberturas frontales de tecnopolimero para enganches de 1 panel Mitesco. OPCIONAL (el panel Mitesco ya incluye las coberturas frontales en color gris o blanco)
7M102-2005	Tortora Dove-grey Taupe Tórtola Taubengrau	1 coppia / 1 pair 1 paire / 1 pare 1 Paar	Paar Abdeckungen aus Technopolymer für Befestigung für 1 Paneel Mitesco. OPTIONAL erhältlich (Mitesco-Paneele werden standardmäßig mit grauen oder weissen Befestigungsabdeckungen geliefert).
7M102-3008	Giallo Yellow Jaune Amarillo Gelbe	1 coppia / 1 pair 1 paire / 1 pare 1 Paar	NOTA Non utilizzare con staffe scrivania cod. 7M511-XX / 7M515-XX / 7M5100-XX / 7M519-XX / 7M518-XX / 7M517-XX (XX = Variante colore). Not to be used with desk brackets code 7M511-XX / 7M515-XX / 7M5100-XX / 7M519-XX / 7M518-XX / 7M517-XX (XX = colour option).
7M102-4030	Arancione Orange Orange Anaranjado Orange	1 coppia / 1 pair 1 paire / 1 pare 1 Paar	Ne pas utiliser avec étriers pour bureau réf 7M511-XX / 7M515-XX / 7M5100-XX / 7M519-XX / 7M518-XX / 7M517-XX (XX = option couleur). No utilizar con abrazaderas para mesa cod. 7M511-XX / 7M515-XX / 7M5100-XX / 7M519-XX / 7M518-XX / 7M517-XX (XX = Variante color).
7M102-4027	Rosso Red Rouge Rojo Rot	1 coppia / 1 pair 1 paire / 1 pare 1 Paar	Nicht zur Verwendung mit Halterungen für Tisch Art. 7M511-XX / 7M515-XX / 7M5100-XX / 7M519-XX / 7M518-XX / 7M517-XX (XX = Farbvariante).
7M102-7004	Verde chiaro Light green Vert clair Verde claro Hellgrün	1 coppia / 1 pair 1 paire / 1 pare 1 Paar	
7M102-7013	Verde Green Vert Verde Grüner	1 coppia / 1 pair 1 paire / 1 pare 1 Paar	
7M102-6071	Blu Blue Bleu Azul Blau	1 coppia / 1 pair 1 paire / 1 pare 1 Paar	
7M102-8033	Nero Black Noir Negro Schwarz	1 coppia / 1 pair 1 paire / 1 pare 1 Paar	

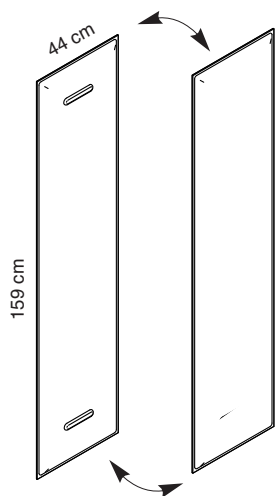

Codice Code	Prezzo Price	Descrizione Description
7MCT160-IN9106		Coperture in tessuto di poliestere Trevira CS® per pannelli Mitesco 7M1016-XXXX, 7M1016BO-XXXX (XXXX = Variante colore). Per ottenere lo stesso risultato in termini di performance acustiche, l'utilizzo delle coperture richiede un aumento del numero di pannelli di circa il 20%. Non indicate per pannelli applicati a soffitto.
7MCT160-IN9222		Covers for Mitesco panels made of polyester fabric Trevira CS® codes 7M1016-XXXX, 7M1016BO-XXXX (XXXX = colour option) To achieve the same result in terms of acoustic performance when using the fabric covers you need to increase the number of panels by approximately 20% Not suitable for ceiling mounted panels.
7MCT160-IN9404		Revêtements en tissu polyester Trevira CS pour panneaux Mitesco 7M1016-XXXX, 7M1016BO-XXXX (XXXX = option couleur) Pour obtenir le même résultat en termes de performance acoustique, l'utilisation des revêtements comporte une augmentation du nombre de panneaux d'environ le 20%. Pas adaptées pour panneaux avec fixation au plafond.
7MCT160-IN9601		Coberturas en tejido de poliester Trevira CS para paneles Mitesco 7M1016-XXXX, 7M1016BO-XXXX (XXXX variante color). Para obtener el mismo resultado en tema de performance acusticas la utilizacion de las coberturas requieren un aumento en el numero de paneles aproximadamente del 20% No indicadas para paneles montados en el techo
7MCT160-IN9809		Verkleidungen für Mitesco Paneele aus Polyesterstoff Trevira CS® 7M1016-XXXX, 7M1016BO-XXXX (XXXX = Farbvariante). Um den gleichen Effekt hinsichtlich der Akustikoptimierung zu erreichen, sollte bei Verwendung der Stoffbezüge die Anzahl der Paneele um ca. 20 % erhöht werden. Nicht geeignet für Paneele, die an der Decke befestigt werden.
7MCT160-AR8006		
7MCT160-AR8070		
7MCT160-CL9309		
7MCT160-CL9702		

MITESCO EASY

design Michele De Lucchi
Snowsound® technology by Caimi Brevetti

Codice Code	Colore Colour	Prezzo Price	Descrizione Description
----------------	------------------	-----------------	----------------------------

7M210-GR

Grigio
Silver
Gris
Gris
Grau

Aggancio semplice in tecnopolimero per fissaggio a parete tramite chiodo/vite (non inclusi) di un pannello Mitesco.

Easy connection in high-tech polymer for wall fixing by nail/screw (not included) of 1 Mitesco panel.

Accrochage simple en technopolymère pour fixation au mur par un clou/vis (pas inclus) d'un panneau Mitesco.

Enganche simple de polímero para fijación a pared por medio de clavo / tornillo (no incluydo) de un panel Mitesco.

Einfache Befestigung aus Technopolymer für die Wandmontage mittels Nagel/Schraube (nicht inkludiert) eines Mitesco-Paneels.



7M2320-GR page 15

MAGNETIC



MITESCO MAGNETIC

design Michele De Lucchi
Snowsound® technology by Caimi Brevetti

	Codice Code	Colore Colour	Prezzo Price	Descrizione Description
<p>Fe = Ferro Iron Fer Hierro Eisen</p>	7M232			<p>Kit 4 magneti per il fissaggio diretto ad una superficie verticale in ferro di un pannello Mitesco.</p> <p>Set of 4 magnets for direct fixing to a vertical iron surface, of 1 Mitesco panel.</p> <p>Jeu de 4 aimants pour la fixation directe à une surface verticale en fer d'un panneau Mitesco.</p> <p>Kit de 4 imanes para la fijación directa a una superficie vertical de hierro de un panel Mitesco.</p> <p>Set von 4 Magneten zur direkten Befestigung auf einer vertikal Eisenoberfläche, für 1 Mitesco-Paneel.</p>
<p>(1)</p> <p>(2)</p>	7M2320-GR			<p>Kit per il fissaggio ad una superficie verticale in vetro o in muratura di un pannello Mitesco.</p> <p>Il kit è composto da: 4 magneti (A) / 4 dischi in acciaio e tecnopolimero grigio (B) / 4 dischi con biadesivo (C).</p> <p>(1) Per le superfici in vetro applicare gli appositi dischetti con biadesivo (C). (2) Per le superfici in muratura applicare direttamente i dischetti (B) tramite viti (non incluse)</p> <p>Set for fixing to a glass or masonry vertical surface, of 1 Mitesco panel.</p> <p>Set composed of: 4 magnets (A) / 4 steel and high-tech polymer plates (B) / 4 plates with double-sided adhesive tape (C).</p> <p>(1) For glass surfaces use the suitable plates with double-sided adhesive tape (C) (2) For masonry surfaces fix directly the plates (B) with screws (not included)</p> <p>Jeu pour fixation à une surface verticale en verre ou maçonnerie d'un panneau Mitesco.</p> <p>Le jeu se compose de: 4 aimants (A) / 4 disques en acier et technopolymère (B) / 4 disques avec bande biadhésive (C).</p> <p>(1) Pour les surfaces en verre appliquer les disques par bande biadhésive (C) (2) Pour les surfaces en maçonnerie appliquer directement les disques (B) par des vis (pas incluses)</p> <p>Kit para fijación a una superficie vertical de vidrio o de mampostería de un panel Mitesco.</p> <p>Kit compuesto por: 4 imanes (A) / 4 discos de acero y polímero (B) / 4 discos con bi-adesivo (C).</p> <p>(1) Para las superficies de vidrio aplicar los discos con su propio bi-adesivo (C) (2) Para las superficies de mampostería aplicar directamente los discos (B) con tornillos (no incluidos)</p> <p>Set zur Montage auf vertikal Glasoberflächen und Mauerwerk, für 1 Mitesco-Paneel.</p> <p>Set von: 4 Magneten (A) / 4 Scheiben aus Stahl und Technopolymer (B) / 4 doppelseitig klebende Scheiben (C).</p> <p>(1) Für Glasoberflächen verwenden Sie die entsprechenden doppelseitig klebenden Scheiben (C) (2) Für Mauerwerk befestigen Sie die Scheiben direkt (B) mit Schrauben (nicht inkludiert)</p>

MITESCO CEILING

design Michele De Lucchi
Snowsound® technology by Caimi Brevetti

	Codice Code	Colore Colour	Prezzo Price	Descrizione Description
	<p>7M160-GA</p>	<p>Grigio argento Silver grey Gris argenté Gris plata Silbergrau</p>	<p>Per pannelli For panels L. 159 cm</p>	<p>Profilo livellatore in acciaio verniciato con polveri epossidiche e tecnopolimero per 1 pannello Mitesco: 7M1016-XXXX, 7M1016BO-XXXX (XXXX = Variante colore). Utilizzare sempre in caso di fissaggio del pannello al soffitto in posizione orizzontale (parallela al piano).</p> <p>Leveler profile in powder coated steel and high-tech polymer for 1 Mitesco panel code: 7M1016-XXXX, 7M1016BO-XXXX (XXXX = colour option). To be always used in case of fixation of the panel to the ceiling in horizontal position (parallel to the floor).</p> <p>Profil niveleur en acier peint en époxy et technopolymère pour un panneau Mitesco: 7M1016-XXXX, 7M1016BO-XXXX (XXXX = option couleur). Toujours à prévoir en cas d'accrochage du panneau au plafond en position horizontale (parallèle à la surface).</p> <p>Perfil nivelador de acero recubierto epoxi y polímero para 1 panel Mitesco cod. 7M1016-XXXX, 7M1016BO-XXXX (XXXX = opción color). Utilizar siempre en caso de enganche del panel al techo en posición horizontal (paralelo al plano).</p> <p>Justierungsprofil aus pulverbeschichtetem Stahl und Technopolymer für 1 Mitesco-Paneel Art.-Nr. 7M1016-XXXX, 7M1016BO-XXXX (XXXX = Farbvariante). Immer verwenden wenn das Paneel in horizontaler Position an der Decke befestigt wird. (Parallel zur Ebene).</p>
	<p>7M120-GA</p>	<p>Grigio argento Silver grey Gris argenté Gris plata Silbergrau</p>	<p>Per pannelli For panels L. 119 cm</p>	<p>Profilo livellatore in acciaio verniciato con polveri epossidiche e tecnopolimero per 1 pannello Mitesco: 7M1012-XXXX, 7M1012BO-XXXX (XXXX = Variante colore). Utilizzare sempre in caso di fissaggio del pannello al soffitto in posizione orizzontale (parallela al piano).</p> <p>Leveler profile in powder coated steel and high-tech polymer for 1 Mitesco panel code: 7M1012-XXXX, 7M1012BO-XXXX (XXXX = colour option). To be always used in case of fixation of the panel to the ceiling in horizontal position (parallel to the floor).</p> <p>Profil niveleur en acier peint en époxy et technopolymère pour un panneau Mitesco: 7M1012-XXXX, 7M1012BO-XXXX (XXXX = option couleur). Toujours à prévoir en cas d'accrochage du panneau au plafond en position horizontale (parallèle à la surface).</p> <p>Perfil nivelador de acero recubierto epoxi y polímero para 1 panel Mitesco cod. 7M1012-XXXX, 7M1012BO-XXXX (XXXX = opción color). Utilizar siempre en caso de enganche del panel al techo en posición horizontal (paralelo al plano).</p> <p>Justierungsprofil aus pulverbeschichtetem Stahl und Technopolymer für 1 Mitesco-Paneel Art.-Nr. 7M1012-XXXX, 7M1012BO-XXXX (XXXX = Farbvariante). Immer verwenden wenn das Paneel in horizontaler Position an der Decke befestigt wird. (Parallel zur Ebene).</p>
	<p>7M80-GA</p>	<p>Grigio argento Silver grey Gris argenté Gris plata Silbergrau</p>	<p>Per pannelli For panels L. 75 cm</p>	<p>Profilo livellatore in acciaio verniciato con polveri epossidiche e tecnopolimero per 1 pannello Mitesco: 7M1008-XXXX, 7M1008BO-XXXX (XXXX = Variante colore). Utilizzare sempre in caso di fissaggio del pannello al soffitto in posizione orizzontale (parallela al piano).</p> <p>Leveler profile in powder coated steel and high-tech polymer for 1 Mitesco panel code: 7M1008-XXXX, 7M1008BO-XXXX (XXXX = colour option). To be always used in case of fixation of the panel to the ceiling in horizontal position (parallel to the floor).</p> <p>Profil niveleur en acier peint en époxy et technopolymère pour un panneau Mitesco: 7M1008-XXXX, 7M1008BO-XXXX (XXXX = option couleur). Toujours à prévoir en cas d'accrochage du panneau au plafond en position horizontale (parallèle à la surface).</p> <p>Perfil nivelador de acero recubierto epoxi y polímero para 1 panel Mitesco cod. 7M1008-XXXX, 7M1008BO-XXXX (XXXX = opción color). Utilizar siempre en caso de enganche del panel al techo en posición horizontal (paralelo al plano).</p> <p>Justierungsprofil aus pulverbeschichtetem Stahl und Technopolymer für 1 Mitesco-Paneel Art.-Nr. 7M1008-XXXX, 7M1008BO-XXXX (XXXX = Farbvariante). Immer verwenden wenn das Paneel in horizontaler Position an der Decke befestigt wird. (Parallel zur Ebene).</p>

MITESCO WALL/CEILING

design Michele De Lucchi
Snowsound® technology by Caimi Brevetti

	Codice Code	Colore Colour	Prezzo Price	Descrizione Description
	7M2476-GA	Grigio argento Silver grey Gris argenté Gris plata Silbergrau	Per pannelli For panels L. 159 cm	Coppia attacchi distanziali in acciaio verniciato con polveri epossidiche e tecnopolimero per parete/soffitto, completi di profilo livellatore per pannello Mitesco. Pair of spacer connections in powder coated steel and high-tech polymer for wall/ceiling, supplied with leveler profile for Mitesco panel.
	7M2472-GA	Grigio argento Silver grey Gris argenté Gris plata Silbergrau	Per pannelli For panels L. 119 cm	Paire d'accrochages espaceurs en acier peint en époxy et technopolymère pour mur/plafond, avec un profil niveleur pour panneau Mitesco.
	7M2478-GA	Grigio argento Silver grey Gris argenté Gris plata Silbergrau	Per pannelli For panels L. 75 cm	Par de enganches espaciadores de acero recubierto epoxi y polímero para pared/techo, incluye perfil nivelador para panel Mitesco. Paar Distanzhalterbefestigungen aus pulverbeschichtetem Stahl und Technopolymer zur Wand- oder Deckenmontage, inkl. Justierungsprofil für Mitesco-Paneel.
<p>Esempio di montaggio del pannello a parete / Example of mounting for a wall fixed panel</p>	<p>Esempio di montaggio del pannello a soffitto / Example of mounting for a ceiling fixed panel</p>			
	7M2426-GA	Grigio argento Silver grey Gris argenté Gris plata Silbergrau	Per pannelli For panels L. 159 cm	Coppia attacchi distanziali in acciaio verniciato con polveri epossidiche e tecnopolimero per parete/soffitto, completi di profilo livellatore per pannello Mitesco. Pair of spacer connections in powder coated steel and high-tech polymer for wall/ceiling, supplied with leveler profile for Mitesco panel.
	7M2422-GA	Grigio argento Silver grey Gris argenté Gris plata Silbergrau	Per pannelli For panels L. 119 cm	Paire d'accrochages espaceurs en acier peint en époxy et technopolymère pour mur/plafond, avec un profil niveleur pour panneau Mitesco.
	7M2428-GA	Grigio argento Silver grey Gris argenté Gris plata Silbergrau	Per pannelli For panels L. 75 cm	Par de enganches espaciadores de acero recubierto epoxi y polímero para pared/techo, incluye perfil nivelador para panel Mitesco. Paar Distanzhalterbefestigungen aus pulverbeschichtetem Stahl und Technopolymer zur Wand- oder Deckenmontage, inkl. Justierungsprofil für Mitesco-Paneel.
<p>Esempio di montaggio del pannello a parete / Example of mounting for a wall fixed panel</p>	<p>Esempio di montaggio del pannello a soffitto / Example of mounting for a ceiling fixed panel</p>			

MITESCO ON CABLES

design Michele De Lucchi
Snowsound® technology by Caimi Brevetti

Codice Code	Colore Colour	Prezzo Price	Descrizione Description
7M214			<p data-bbox="975 226 1382 275">Kit 4 morsetti in metallo per cavi cod. 7M5170. Applicabili direttamente a un pannello Mitesco.</p> <p data-bbox="975 309 1441 356">Set of 4 steel clamps to use with cables code 7M5170 They can be applied directly to the Mitesco panel.</p> <p data-bbox="975 389 1469 436">Jeu de 4 étaux en métal pour cables réf. 7M5170. On peut les appliquer directement à un panneau Mitesco.</p> <p data-bbox="975 470 1457 517">Kit de 4 sujetadores de metal para cables cod. 7M5170. Aplicables directamente a un panel Mitesco.</p> <p data-bbox="975 551 1430 622">Set von 4 Klemmen zur Verwendung mit Stahlseilen Art. 7M5170. Befestigung der Klemmen direkt am Mitesco-Panel.</p>
7M5170			<p data-bbox="975 920 1393 943">1 coppia cavi d'acciaio (4+4 m) + 1 coppia tiranti</p> <p data-bbox="831 954 967 1021">1 coppia / 1 pair 1 paire / 1 par 1 Paar</p> <p data-bbox="975 976 1401 999">Pair of steel cables (4+4 m) + pair of tension rods</p> <p data-bbox="975 1021 1409 1043">Paire de cables en acier (4+4 m) + paire de tirants</p> <p data-bbox="975 1066 1382 1088">Par de cables de acero (4+4 m) + par de pesos</p> <p data-bbox="975 1111 1493 1155">1 Paar Stahlseile (4+4 m) + 1 Paar Befestigungsendstücken</p>

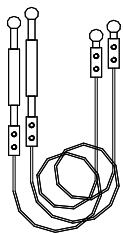
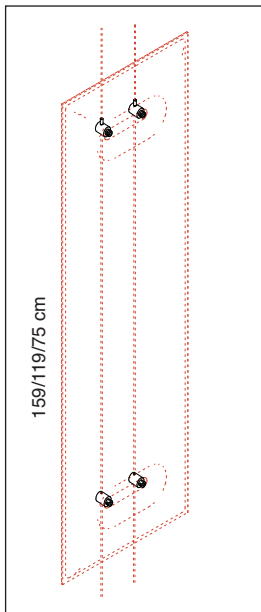
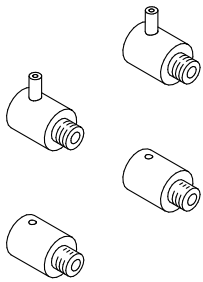

MITESCO ON CABLES

design Michele De Lucchi
Snowsound® technology by Caimi Brevetti

	Codice Code	Colore Colour	Prezzo Price	Descrizione Description
	7M5158-GA	Grigio argento Silver grey Gris argenté Gris plata Silbergrau	2 coppie / 2 pairs 2 paires / 2 pares 2 Paar	<p>2 coppie supporti in acciaio verniciato con polveri epossidiche per fissaggio a parete per cod. 7M5170. (Viti non incluse)</p> <p>2 pairs of powder-coated supports for wall fixing for code 7M5170. (Screws not included)</p> <p>2 paires de supports en acier peint pour fixation murale pour réf. 7M5170. (Vis pas incluses)</p> <p>2 pares de soportes de acero recubierto epoxi para fijación a pared para cod. 7M5170. (Tornillos no incluidos)</p> <p>2 Paar Wandbefestigungen aus pulverbeschichtetem Stahl für Art. 7M5170. (Schrauben nicht inkludiert)</p>
	7M5159-GA	Grigio argento Silver grey Gris argenté Gris plata Silbergrau	2 coppie / 2 pairs 2 paires / 2 pares 2 Paar	<p>2 coppie in acciaio verniciato con polveri epossidiche per fissaggio a pavimento/soffitto per cod. 7M5170. (Viti non incluse)</p> <p>2 pairs of powder-coated steel supports for floor/ceiling fixing for code 7M5170. (Screws not included)</p> <p>2 paires de supports en acier peint époxy pour fixation sol/plafond pour réf. 7M5170. (Vis pas incluses)</p> <p>2 pares de soportes de acero recubierto epoxi para fijación suelo/techo para cod. 7M5170. (Tornillos no incluidos)</p> <p>2 Paar Decken/Bodenbefestigungen aus pulverbeschichtetem Stahl für Art. 7M5170. (Schrauben nicht inkludiert)</p>
	7M5140	Grigio argento Silver grey Gris argenté Gris plata Silbergrau	1 coppia / 1 pair 1 paire / 1 par 1 Paar	<p>1 coppia supporti in acciaio verniciato con polveri epossidiche per fissaggio a parete per cod. 7M5170. (Viti non incluse)</p> <p>1 pair of powder-coated steel supports for wall fixing for code 7M5170. (Screws not included)</p> <p>1 paire de supports en acier peint époxy pour fixation murale pour réf. 7M5170. (Vis pas incluses)</p> <p>1 par de soportes de acero recubierto epoxi para fijación a pared para cod. 7M5170. (Tornillos no incluidos)</p> <p>1 Paar Wandbefestigungen aus pulverbeschichtetem Stahl für Art. 7M5170. (Schrauben nicht inkludiert)</p>
	7M5142	Grigio argento Silver grey Gris argenté Gris plata Silbergrau	1 coppia / 1 pair 1 paire / 1 par 1 Paar	<p>1 coppia supporti in acciaio verniciato con polveri epossidiche per fissaggio a pavimento/soffitto per cod. 7M5170. (Viti non incluse)</p> <p>1 pair of powder-coated steel supports for floor/ceiling fixing for code 7M5170. (Screws not included)</p> <p>1 paire de supports en acier peint époxy pour fixation sol/plafon pour réf. 7M5170. (Vis pas incluses)</p> <p>1 par de soportes de acero recubierto epoxi para fijación a suelo/techo para cod. 7M5170. (Tornillos no incluidos)</p> <p>1 Paar Decken/Bodenbefestigungen aus pulverbeschichtetem Stahl für Art. 7M5170. (Schrauben nicht inkludiert)</p>





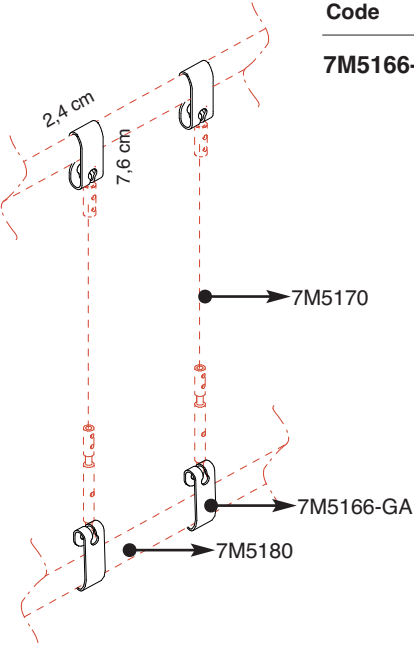
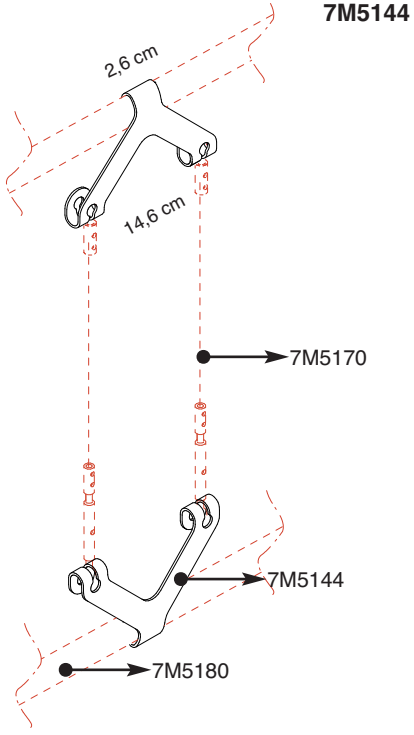

MITESCO ON CABLES

design Michele De Lucchi
Snowsound® technology by Caimi Brevetti

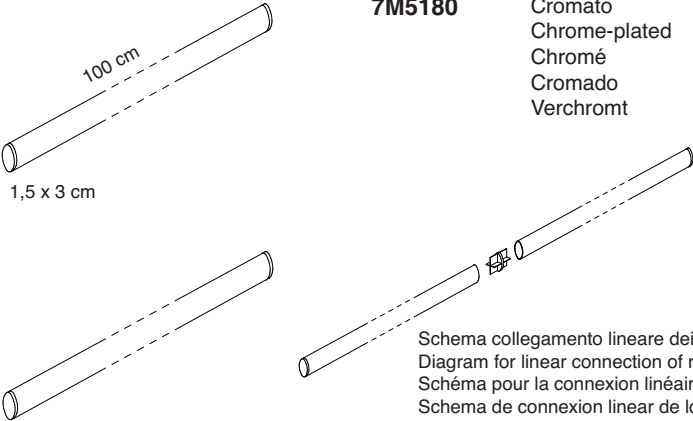
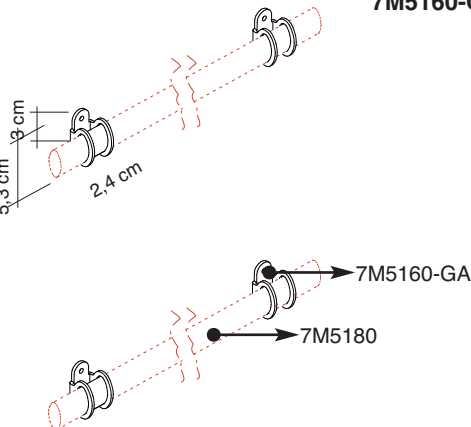
Codice Code	Colore Colour	Prezzo Price	Descrizione Description
7M5166-GA	Grigio argento Silver grey Gris argenté Gris plata Silbergrau	2 coppie / 2 pairs 2 paires / 2 pares 2 Paar	2 coppie supporti in acciaio verniciato con polveri epossidiche per cod. 7M5180 e 7M5170 2 paires de supports en acier peint époxy pour réf. 7M5180 et 7M5170 2 pares de soportes de acero recubierto epoxi para cod. 7M5180 y 7M5170 2 Paar Befestigungshaken aus pulverbeschichtetem Stahl für Art. 7M5180 und 7M5170
			
7M5144	Grigio argento Silver grey Gris argenté Gris plata Silbergrau	1 coppia / 1 pair 1 paire / 1 par 1 Paar	1 coppia supporti in acciaio verniciato con polveri epossidiche per cod. 7M5180 e 7M5170. 1 pair of powder-coated steel supports for code 7M5180 and 7M5170 1 paire de supports en acier peint epoxy pour réf. 7M5180 et 7M5170 1 par de soportes de acero recubierto epoxi para cod. 7M5180 y 7M5170 1 Paar Befestigungshaken aus pulverbeschichtetem Stahl für Art. 7M5180 und 7M5170
			

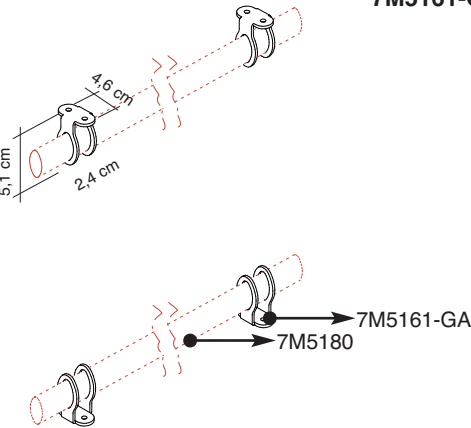
MITESCO ON CABLES

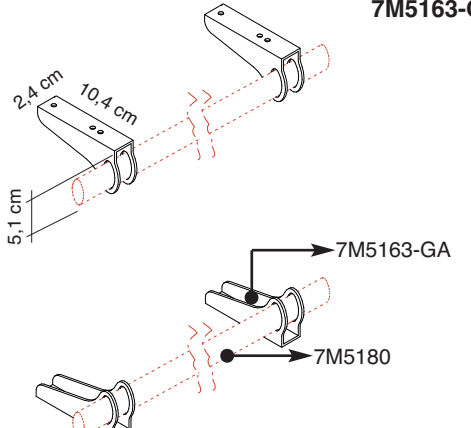
design Michele De Lucchi
Snowsound® technology by Caimi Brevetti

	Codice Code	Colore Colour	Prezzo Price	Descrizione Description
 <p>100 cm 1,5 x 3 cm</p> <p>Schema collegamento lineare dei tubi Diagram for linear connection of rails Schéma pour la connexion linéaire des tubes Schema de connexion linear de los tubos Schema der gerader Stangenverbindung</p>	7M5180	Cromato Chrome-plated Chromé Cromado Verchromt	1 coppia / 1 pair 1 paire / 1 par 1 Paar	Coppia tubi ellittici in acciaio cromato completi di giunto per collegamento lineare. Pair of elliptical rails in chrome-plated steel with joint for linear connection Paire de tubes elliptiques en acier chromé avec jonction pour connexion linéaire Par de tubos elícticos de acero cromado con enganche para enlace linear incluido 1 Paar ovale Stangen aus verchromtem Stahl mit geradem Verbindungsstück
 <p>5,3 cm 2,4 cm</p> <p>7M5160-GA 7M5180</p> 	7M5160-GA	Grigio argento Silver grey Gris argenté Gris plata Silbergrau	2 coppie / 2 pairs 2 paires / 2 pares 2 Paar	2 coppie fissaggi a parete in acciaio verniciato con polveri epossidiche per cod. 7M5180. (Viti non incluse) 2 pairs of powder-coated steel wall connections for code 7M5180. (Screws not included) 2 paires de fixations murales en acier peint époxy pour réf. 7M5180. (Vis pas incluses) 2 pares de soportes a pared de acero recubierto epoxi para cod. 7M5180. (Tornillos no incluidos) 2 Paar Wandbefestigungen aus pulverbeschichtetem Stahl für Art. 7M5180. (Schrauben nicht inkludiert)
 <p>5,1 cm 4,6 cm 2,4 cm</p> <p>7M5161-GA 7M5180</p> 	7M5161-GA	Grigio argento Silver grey Gris argenté Gris plata Silbergrau	2 coppie / 2 pairs 2 paires / 2 pares 2 Paar	2 coppie fissaggi a soffitto/pavimento in acciaio verniciato con polveri epossidiche per cod. 7M5180. (Viti non incluse) 2 pairs of powder-coated steel floor/ceiling connections for code 7M5180. (Screws not included) 2 paires de fixations sol/plafond en acier peint époxy pour réf. 7M5180. (Vis pas incluses) 2 pares de soportes suelo/techo de acero recubierto epoxi para cod. 7M5180. (Tornillos no incluidos) 2 Paar Decken/Bodenbefestigungen aus pulverbeschichtetem Stahl für Art. 7M5180. (Schrauben nicht inkludiert)
 <p>5,1 cm 2,4 cm 10,4 cm</p> <p>7M5163-GA 7M5180</p> 	7M5163-GA	Grigio argento Silver grey Gris argenté Gris plata Silbergrau	2 coppie / 2 pairs 2 paires / 2 pares 2 Paar	2 coppie fissaggi a soffitto/pavimento in acciaio verniciato con polveri epossidiche per cod. 7M5180. (Viti non incluse) 2 pairs of powder-coated steel floor/ceiling connections for code 7M5180. (Screws not included) 2 paires de fixations sol/plafond en acier peint époxy pour réf. 7M5180. (Vis pas incluses) 2 pares de soportes suelo/techo de acero recubierto epoxi para cod. 7M5180. (Tornillos no incluidos) 2 Paar Decken/Bodenbefestigungen aus pulverbeschichtetem Stahl für Art. 7M5180. (Schrauben nicht inkludiert)

MITESCO TOTEM

design Michele De Lucchi
Snowsound® technology by Caimi Brevetti

Codice Code	Colore Colour	Prezzo Price	Descrizione Description
7M1070-GA	Grigio argento Silver grey Gris argenté Gris plata Silbergrau		Struttura in acciaio verniciato con polveri epossidiche con base in ghisa verniciata con polveri epossidiche per il montaggio di 1 pannello Mitesco 7M1016-XXXX, 7M1016BO-XXXX (XXXX = Variante colore).
7M1070-BO	Bianco opaco Mat white Blanc mat Blanco mate Mattweiß		Structure in powder-coated steel with base in powder-coated cast iron to mount 1 Mitesco panel code 7M1016-XXXX, 7M1016BO-XXXX (XXXX = colour option). Structure en acier peint époxy avec base en fonte peinte époxy pour le montage de 1 panneau Mitesco réf. 7M1016-XXXX, 7M1016BO-XXXX (XXXX = option couleur) Estructura de acero recubierto epoxi con base de hierro fundido recubierto epoxi para el montaje de 1 panel Mitesco 7M1016-XXXX, 7M1016BO-XXXX (XXXX = Variante color). Standsäule aus pulverbeschichtetem Stahl mit Standfuß aus pulverbeschichtetem Gusseisen zur Aufstellung von 1 Mitesco-Panel Art. 7M1016-XXXX, 7M1016BO-XXXX (XXXX = Farbvariante).

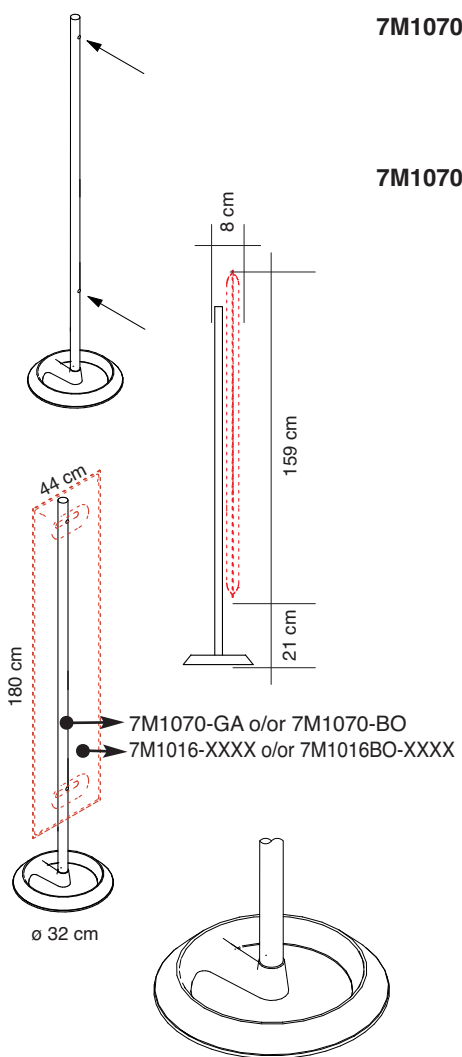

7M1070-GA o/or 7M1070-BO
7M1016-XXXX o/or 7M1016BO-XXXX

Dettaglio della base
Detail of the base
Détail de la base
Detalle de la base
Details der Basis



	7M1697	Alluminio lucidato Polished aluminium Aluminium poli Aluminio pulido Poliertem Aluminium	Gancio portabiti in alluminio lucidato per strutture cod. 7M1070-GA e 7M1070-BO. OPZIONALE
			Polished aluminium hook for structures code 7M1070-GA e 7M1070-BO. OPTIONAL
			Crochet en aluminium poli pour structures code 7M1070-GA e 7M1070-BO. OPTIONNEL
			Gancho en aluminio pulido para estructuras code 7M1070-GA e 7M1070-BO. OPCIONAL
			Haken aus poliertem Aluminium für Standsäule Art 7M1070-GA e 7M1070-BO. OPTIONAL erhältlich

MITESCO TOTEM

design Michele De Lucchi
Snowsound® technology by Caimi Brevetti

Codice Code	Colore Colour	Prezzo Price	Descrizione Description
----------------	------------------	-----------------	----------------------------

7M1072-GA Grigio argento
Silver grey
Gris argenté
Gris plata
Silbergrau

7M1072-BO Bianco opaco
Mat white
Blanc mat
Blanco mate
Mattweiß

Struttura in acciaio verniciato con polveri epossidiche con base in ghisa verniciata con polveri epossidiche per il montaggio di **2** pannelli Mitesco (1 pannello per lato)
7M1016-XXXX, 7M1016BO-XXXX
(XXXX = Variante colore).

Structure in powder-coated steel with base in powder-coated cast iron to mount **2** Mitesco panels (1 panel on each side)
code 7M1016-XXXX, 7M1016BO-XXXX
(XXXX = colour option).

Structure en acier peint époxy avec base en fonte peinte époxy pour le montage de **2** panneaux Mitesco (1 de chaque côté) réf. 7M1016-XXXX, 7M1016BO-XXXX
(XXXX = option couleur)

Estructura de acero recubierto epoxi con base de hierro fundido recubierto epoxi para el montaje de **2** panels Mitesco (1 por cada lado) 7M1016-XXXX, 7M1016BO-XXXX
(XXXX = Variante color).

Standsäule aus pulverbeschichtetem Stahl mit Standfuß aus pulverbeschichtetem Gusseisen zur Aufstellung von **2** Mitesco-Paneelen (1 pro Seite) Art. 7M1016-XXXX, 7M1016BO-XXXX (XXXX = Farbvariante).

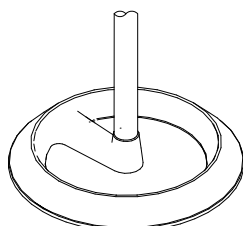
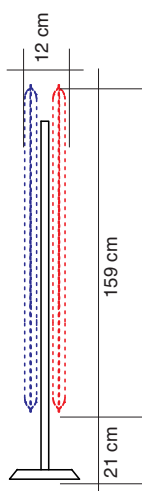
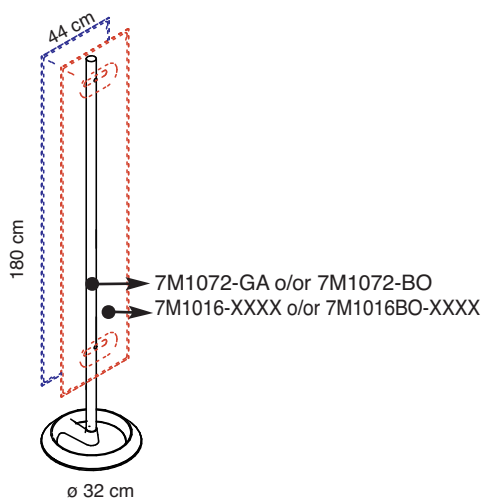
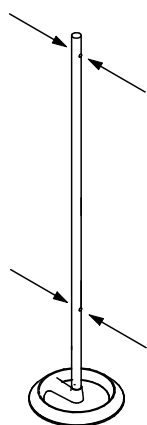

Dettaglio della base
Detail of the base
Détail de la base
Detalle de la base
Details der Basis



MITESCO DIVIDER

design Michele De Lucchi
Snowsound® technology by Caimi Brevetti



Per / for
7M3650-XX / 7M3250-XX / 7M3850-XX
7M3630-XX / 7M3230-XX / 7M3830-XX
7M3625-XX / 7M3225-XX / 7M3825-XX



MITESCO DIVIDER

design Michele De Lucchi
Snowsound® technology by Caimi Brevetti

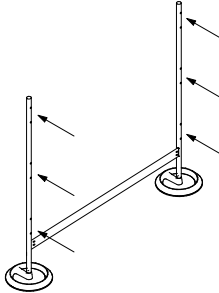
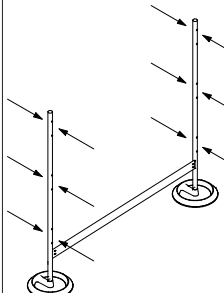
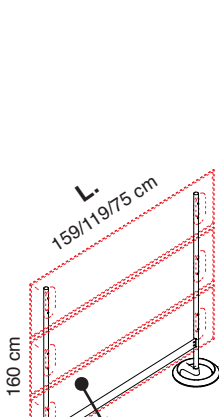
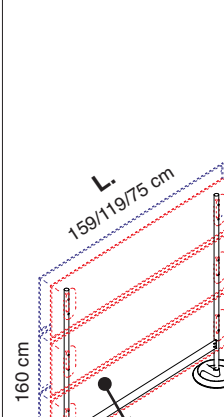
	Codice Code	Colore Colour	Prezzo Price		Codice Code	Colore Colour	Prezzo Price																																										
STRUTTURA MONOFRONTA ONE-SIDED FRAME 	7M3670-GA	Grigio argento Silver grey Gris argenté Gris plata Silbergrau	Per pannelli For panels L. 159 cm	STRUTTURA BIFRONTA DOUBLE-SIDED FRAME 	7M6670-GA	Grigio argento Silver grey Gris argenté Gris plata Silbergrau	Per pannelli For panels L. 159 cm																																										
	7M3670-BO	Bianco opaco Mat white Blanc mat Blanco mate Mattweiß	Per pannelli For panels L. 159 cm		7M6670-BO	Bianco opaco Mat white Blanc mat Blanco mate Mattweiß	Per pannelli For panels L. 159 cm																																										
	7M3270-GA	Grigio argento Silver grey Gris argenté Gris plata Silbergrau	Per pannelli For panels L. 119 cm		7M6270-GA	Grigio argento Silver grey Gris argenté Gris plata Silbergrau	Per pannelli For panels L. 119 cm																																										
	7M3270-BO	Bianco opaco Mat white Blanc mat Blanco mate Mattweiß	Per pannelli For panels L. 119 cm		7M6270-BO	Bianco opaco Mat white Blanc mat Blanco mate Mattweiß	Per pannelli For panels L. 119 cm																																										
	7M3870-GA	Grigio argento Silver grey Gris argenté Gris plata Silbergrau	Per pannelli For panels L. 75 cm		7M6870-GA	Grigio argento Silver grey Gris argenté Gris plata Silbergrau	Per pannelli For panels L. 75 cm																																										
	7M3870-BO	Bianco opaco Mat white Blanc mat Blanco mate Mattweiß	Per pannelli For panels L. 75 cm		7M6870-BO	Bianco opaco Mat white Blanc mat Blanco mate Mattweiß	Per pannelli For panels L. 75 cm																																										
		<table border="1"> <tr> <td>A</td> <td>7M1016-XXXX o/or 7M1016BO-XXXX</td> <td rowspan="2">L. 159 cm</td> </tr> <tr> <td>B</td> <td>7M3670-GA o/or 7M3670-BO</td> </tr> <tr> <td colspan="3" style="text-align: center;">o/or</td> </tr> <tr> <td>A</td> <td>7M1012-XXXX o/or 7M1012BO-XXXX</td> <td rowspan="2">L. 119 cm</td> </tr> <tr> <td>B</td> <td>7M3270-GA o/or 7M3270-BO</td> </tr> <tr> <td colspan="3" style="text-align: center;">o/or</td> </tr> <tr> <td>A</td> <td>7M1008-XXXX o/or 7M1008BO-XXXX</td> <td rowspan="2">L. 75 cm</td> </tr> <tr> <td>B</td> <td>7M3870-GA o/or 7M3870-BO</td> </tr> </table>			A	7M1016-XXXX o/or 7M1016BO-XXXX	L. 159 cm	B	7M3670-GA o/or 7M3670-BO	o/or			A	7M1012-XXXX o/or 7M1012BO-XXXX	L. 119 cm	B	7M3270-GA o/or 7M3270-BO	o/or			A	7M1008-XXXX o/or 7M1008BO-XXXX	L. 75 cm	B	7M3870-GA o/or 7M3870-BO		<table border="1"> <tr> <td>A</td> <td>7M1016-XXXX o/or 7M1016BO-XXXX</td> <td rowspan="2">L. 159 cm</td> </tr> <tr> <td>B</td> <td>7M6670-GA o/or 7M6670-BO</td> </tr> <tr> <td colspan="3" style="text-align: center;">o/or</td> </tr> <tr> <td>A</td> <td>7M1012-XXXX o/or 7M1012BO-XXXX</td> <td rowspan="2">L. 119 cm</td> </tr> <tr> <td>B</td> <td>7M6270-GA o/or 7M6270-BO</td> </tr> <tr> <td colspan="3" style="text-align: center;">o/or</td> </tr> <tr> <td>A</td> <td>7M1008-XXXX o/or 7M1008BO-XXXX</td> <td rowspan="2">L. 75 cm</td> </tr> <tr> <td>B</td> <td>7M6870-GA o/or 7M6870-BO</td> </tr> </table>		A	7M1016-XXXX o/or 7M1016BO-XXXX	L. 159 cm	B	7M6670-GA o/or 7M6670-BO	o/or			A	7M1012-XXXX o/or 7M1012BO-XXXX	L. 119 cm	B	7M6270-GA o/or 7M6270-BO	o/or			A	7M1008-XXXX o/or 7M1008BO-XXXX	L. 75 cm	B	7M6870-GA o/or 7M6870-BO
	A	7M1016-XXXX o/or 7M1016BO-XXXX	L. 159 cm																																														
	B	7M3670-GA o/or 7M3670-BO																																															
	o/or																																																
A	7M1012-XXXX o/or 7M1012BO-XXXX	L. 119 cm																																															
B	7M3270-GA o/or 7M3270-BO																																																
o/or																																																	
A	7M1008-XXXX o/or 7M1008BO-XXXX	L. 75 cm																																															
B	7M3870-GA o/or 7M3870-BO																																																
A	7M1016-XXXX o/or 7M1016BO-XXXX	L. 159 cm																																															
B	7M6670-GA o/or 7M6670-BO																																																
o/or																																																	
A	7M1012-XXXX o/or 7M1012BO-XXXX	L. 119 cm																																															
B	7M6270-GA o/or 7M6270-BO																																																
o/or																																																	
A	7M1008-XXXX o/or 7M1008BO-XXXX	L. 75 cm																																															
B	7M6870-GA o/or 7M6870-BO																																																

Struttura in acciaio verniciato con polveri epossidiche con basi in ghisa verniciata con polveri epossidiche per il montaggio di 3 o 6 pannelli Mitesco.

Structure in powder-coated steel with bases in powder-coated cast iron to mount 3 or 6 Mitesco panels.

Structure en acier peint époxy avec bases en fonte peinte époxy pour le montage de 3 ou 6 panneaux Mitesco.

Estructura de acero recubierto epoxi con bases de hierro fundido recubierto epoxi para el montaje de 3 o 6 paneles Mitesco.

Standsäulen aus pulverbeschichtetem Stahl mit Standfuß aus pulverbeschichtetem Gusseisen zur Aufstellung von 3 oder 6 Mitesco-Paneelen.

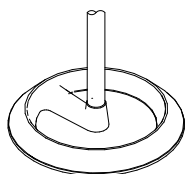

Dettaglio della base
Detail of the base
Détail de la base
Detalle de la base
Details der Basis

MITESCO DIVIDER

design Michele De Lucchi
Snowsound® technology by Caimi Brevetti

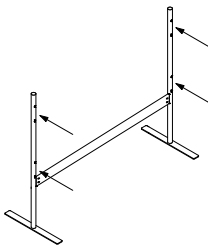
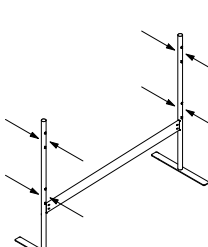
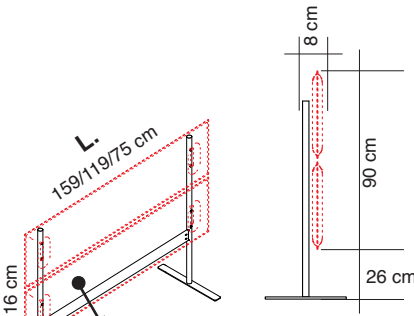
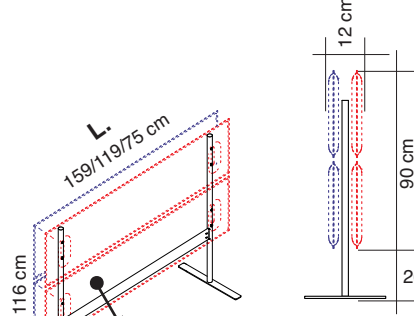
	Codice Code	Colore Colour	Prezzo Price		Codice Code	Colore Colour	Prezzo Price																																								
STRUTTURA MONOFRONTA ONE-SIDED FRAME 	7M0650-GA	Grigio argento Silver grey Gris argenté Gris plata Silbergrau	Per pannelli For panels L. 159 cm	STRUTTURA BIFRONTA DOUBLE-SIDED FRAME 	7M2650-GA	Grigio argento Silver grey Gris argenté Gris plata Silbergrau	Per pannelli For panels L. 159 cm																																								
	7M0650-BO	Bianco opaco Mat white Blanc mat Blanco mate Mattweiß	Per pannelli For panels L. 159 cm		7M2650-BO	Bianco opaco Mat white Blanc mat Blanco mate Mattweiß	Per pannelli For panels L. 159 cm																																								
	7M0250-GA	Grigio argento Silver grey Gris argenté Gris plata Silbergrau	Per pannelli For panels L. 119 cm		7M2250-GA	Grigio argento Silver grey Gris argenté Gris plata Silbergrau	Per pannelli For panels L. 119 cm																																								
	7M0250-BO	Bianco opaco Mat white Blanc mat Blanco mate Mattweiß	Per pannelli For panels L. 119 cm		7M2250-BO	Bianco opaco Mat white Blanc mat Blanco mate Mattweiß	Per pannelli For panels L. 119 cm																																								
	7M0850-GA	Grigio argento Silver grey Gris argenté Gris plata Silbergrau	Per pannelli For panels L. 75 cm		7M2850-GA	Grigio argento Silver grey Gris argenté Gris plata Silbergrau	Per pannelli For panels L. 75 cm																																								
	7M0850-BO	Bianco opaco Mat white Blanc mat Blanco mate Mattweiß	Per pannelli For panels L. 75 cm		7M2850-BO	Bianco opaco Mat white Blanc mat Blanco mate Mattweiß	Per pannelli For panels L. 75 cm																																								
																																															
	<table border="1"> <tr> <td>A</td> <td>7M1016-XXXX o/or 7M1016BO-XXXX</td> <td rowspan="2">L. 159 cm</td> </tr> <tr> <td>B</td> <td>7M0650-GA o/or 7M0650-BO</td> </tr> <tr> <td colspan="3" style="text-align: center;">o/or</td> </tr> <tr> <td>A</td> <td>7M1012-XXXX o/or 7M1012BO-XXXX</td> <td rowspan="2">L. 119 cm</td> </tr> <tr> <td>B</td> <td>7M0250-GA o/or 7M0250-BO</td> </tr> <tr> <td colspan="3" style="text-align: center;">o/or</td> </tr> <tr> <td>A</td> <td>7M1008-XXXX o/or 7M1008BO-XXXX</td> <td rowspan="2">L. 75 cm</td> </tr> <tr> <td>B</td> <td>7M0850-GA o/or 7M0850-BO</td> </tr> </table>		A		7M1016-XXXX o/or 7M1016BO-XXXX	L. 159 cm	B	7M0650-GA o/or 7M0650-BO	o/or			A	7M1012-XXXX o/or 7M1012BO-XXXX	L. 119 cm	B	7M0250-GA o/or 7M0250-BO	o/or			A	7M1008-XXXX o/or 7M1008BO-XXXX	L. 75 cm	B	7M0850-GA o/or 7M0850-BO	<table border="1"> <tr> <td>A</td> <td>7M1016-XXXX o/or 7M1016BO-XXXX</td> <td rowspan="2">L. 159 cm</td> </tr> <tr> <td>B</td> <td>7M2650-GA o/or 7M2650-BO</td> </tr> <tr> <td colspan="3" style="text-align: center;">o/or</td> </tr> <tr> <td>A</td> <td>7M1012-XXXX o/or 7M1012BO-XXXX</td> <td rowspan="2">L. 119 cm</td> </tr> <tr> <td>B</td> <td>7M2250-GA o/or 7M2250-BO</td> </tr> <tr> <td colspan="3" style="text-align: center;">o/or</td> </tr> <tr> <td>A</td> <td>7M1008-XXXX o/or 7M1008BO-XXXX</td> <td rowspan="2">L. 75 cm</td> </tr> <tr> <td>B</td> <td>7M2850-GA o/or 7M2850-BO</td> </tr> </table>		A	7M1016-XXXX o/or 7M1016BO-XXXX	L. 159 cm	B	7M2650-GA o/or 7M2650-BO	o/or			A	7M1012-XXXX o/or 7M1012BO-XXXX	L. 119 cm	B	7M2250-GA o/or 7M2250-BO	o/or			A	7M1008-XXXX o/or 7M1008BO-XXXX	L. 75 cm	B	7M2850-GA o/or 7M2850-BO
	A	7M1016-XXXX o/or 7M1016BO-XXXX	L. 159 cm																																												
	B	7M0650-GA o/or 7M0650-BO																																													
o/or																																															
A	7M1012-XXXX o/or 7M1012BO-XXXX	L. 119 cm																																													
B	7M0250-GA o/or 7M0250-BO																																														
o/or																																															
A	7M1008-XXXX o/or 7M1008BO-XXXX	L. 75 cm																																													
B	7M0850-GA o/or 7M0850-BO																																														
A	7M1016-XXXX o/or 7M1016BO-XXXX	L. 159 cm																																													
B	7M2650-GA o/or 7M2650-BO																																														
o/or																																															
A	7M1012-XXXX o/or 7M1012BO-XXXX	L. 119 cm																																													
B	7M2250-GA o/or 7M2250-BO																																														
o/or																																															
A	7M1008-XXXX o/or 7M1008BO-XXXX	L. 75 cm																																													
B	7M2850-GA o/or 7M2850-BO																																														

Struttura in acciaio verniciato con polveri epossidiche con basi in acciaio verniciato con polveri epossidiche per il montaggio di 2 o 4 pannelli Mitesco.

Structure in powder-coated steel with bases in powder-coated steel to mount 2 ou 4 Mitesco panels.

Structure en acier peint époxy avec bases en acier peint époxy pour le montage de 2 ou 4 panneaux Mitesco.

Estructura de acero recubierto epoxi con bases de acero recubierto epoxi para el montaje de 2 o 4 paneles Mitesco.

Standssäulen aus pulverbeschichtetem Stahl mit Standfuß aus pulverbeschichtetem Stahl zur Aufstellung von 2 oder 4 Mitesco-Paneeelen.

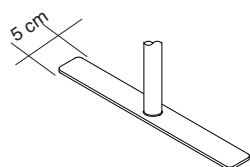

Dettaglio della base
Detail of the base
Détail de la base
Detalle de la base
Details der Basis

MITESCO DIVIDER

design Michele De Lucchi
Snowsound® technology by Caimi Brevetti

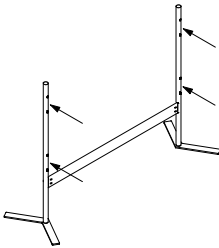
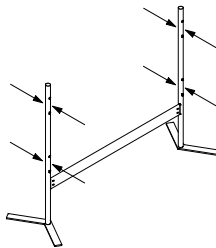
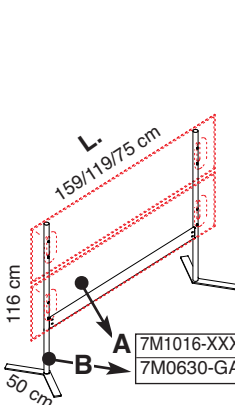
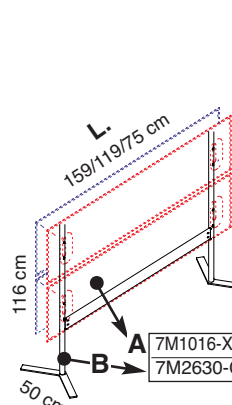
	Codice Code	Colore Colour	Prezzo Price		Codice Code	Colore Colour	Prezzo Price												
STRUTTURA MONOFRONTE ONE-SIDED FRAME 	7M0630-GA	Grigio argento Silver grey Gris argenté Gris plata Silbergrau	Per pannelli For panels L. 159 cm	STRUTTURA BIFRONTE DOUBLE-SIDED FRAME 	7M2630-GA	Grigio argento Silver grey Gris argenté Gris plata Silbergrau	Per pannelli For panels L. 159 cm												
	7M0630-BO	Bianco opaco Mat white Blanc mat Blanco mate Mattweiß	Per pannelli For panels L. 159 cm		7M2630-BO	Bianco opaco Mat white Blanc mat Blanco mate Mattweiß	Per pannelli For panels L. 159 cm												
	7M0230-GA	Grigio argento Silver grey Gris argenté Gris plata Silbergrau	Per pannelli For panels L. 119 cm		7M2230-GA	Grigio argento Silver grey Gris argenté Gris plata Silbergrau	Per pannelli For panels L. 119 cm												
	7M0230-BO	Bianco opaco Mat white Blanc mat Blanco mate Mattweiß	Per pannelli For panels L. 119 cm		7M2230-BO	Bianco opaco Mat white Blanc mat Blanco mate Mattweiß	Per pannelli For panels L. 119 cm												
	7M0830-GA	Grigio argento Silver grey Gris argenté Gris plata Silbergrau	Per pannelli For panels L. 75 cm		7M2830-GA	Grigio argento Silver grey Gris argenté Gris plata Silbergrau	Per pannelli For panels L. 75 cm												
	7M0830-BO	Bianco opaco Mat white Blanc mat Blanco mate Mattweiß	Per pannelli For panels L. 75 cm		7M2830-BO	Bianco opaco Mat white Blanc mat Blanco mate Mattweiß	Per pannelli For panels L. 75 cm												
			<table border="1"> <tr> <td>A</td> <td>7M1016-XXXX o/or 7M1016BO-XXXX</td> <td rowspan="2">L. 159 cm</td> </tr> <tr> <td>B</td> <td>7M0630-GA o/or 7M0630-BO</td> </tr> </table>		A	7M1016-XXXX o/or 7M1016BO-XXXX	L. 159 cm	B	7M0630-GA o/or 7M0630-BO			<table border="1"> <tr> <td>A</td> <td>7M1016-XXXX o/or 7M1016BO-XXXX</td> <td rowspan="2">L. 159 cm</td> </tr> <tr> <td>B</td> <td>7M2630-GA o/or 7M2630-BO</td> </tr> </table>		A	7M1016-XXXX o/or 7M1016BO-XXXX	L. 159 cm	B	7M2630-GA o/or 7M2630-BO	
	A	7M1016-XXXX o/or 7M1016BO-XXXX	L. 159 cm																
	B	7M0630-GA o/or 7M0630-BO																	
	A	7M1016-XXXX o/or 7M1016BO-XXXX	L. 159 cm																
B	7M2630-GA o/or 7M2630-BO																		
<table border="1"> <tr> <td>A</td> <td>7M1012-XXXX o/or 7M1012BO-XXXX</td> <td rowspan="2">L. 119 cm</td> </tr> <tr> <td>B</td> <td>7M0230-GA o/or 7M0230-BO</td> </tr> </table>		A	7M1012-XXXX o/or 7M1012BO-XXXX	L. 119 cm	B	7M0230-GA o/or 7M0230-BO	<table border="1"> <tr> <td>A</td> <td>7M1012-XXXX o/or 7M1012BO-XXXX</td> <td rowspan="2">L. 119 cm</td> </tr> <tr> <td>B</td> <td>7M2230-GA o/or 7M2230-BO</td> </tr> </table>		A	7M1012-XXXX o/or 7M1012BO-XXXX	L. 119 cm	B	7M2230-GA o/or 7M2230-BO						
A	7M1012-XXXX o/or 7M1012BO-XXXX	L. 119 cm																	
B	7M0230-GA o/or 7M0230-BO																		
A	7M1012-XXXX o/or 7M1012BO-XXXX	L. 119 cm																	
B	7M2230-GA o/or 7M2230-BO																		
<table border="1"> <tr> <td>A</td> <td>7M1008-XXXX o/or 7M1008BO-XXXX</td> <td rowspan="2">L. 75 cm</td> </tr> <tr> <td>B</td> <td>7M0830-GA o/or 7M0830-BO</td> </tr> </table>		A	7M1008-XXXX o/or 7M1008BO-XXXX	L. 75 cm	B	7M0830-GA o/or 7M0830-BO	<table border="1"> <tr> <td>A</td> <td>7M1008-XXXX o/or 7M1008BO-XXXX</td> <td rowspan="2">L. 75 cm</td> </tr> <tr> <td>B</td> <td>7M2830-GA o/or 7M2830-BO</td> </tr> </table>		A	7M1008-XXXX o/or 7M1008BO-XXXX	L. 75 cm	B	7M2830-GA o/or 7M2830-BO						
A	7M1008-XXXX o/or 7M1008BO-XXXX	L. 75 cm																	
B	7M0830-GA o/or 7M0830-BO																		
A	7M1008-XXXX o/or 7M1008BO-XXXX	L. 75 cm																	
B	7M2830-GA o/or 7M2830-BO																		

Struttura in acciaio verniciato con polveri epossidiche con basi in acciaio verniciato con polveri epossidiche per il montaggio di **2 o 4** pannelli Mitesco.

Structure in powder-coated steel with bases in powder-coated steel to mount **2 ou 4** Mitesco panels.

Structure en acier peint époxy avec bases en acier peint époxy pour le montage de **2 ou 4** panneaux Mitesco.

Estructura de acero recubierto epoxi con bases de acero recubierto epoxi para el montaje de **2 o 4** paneles Mitesco.

Standssäulen aus pulverbeschichtetem Stahl mit Standfuß aus pulverbeschichtetem Stahl zur Aufstellung von **2 oder 4** Mitesco-Paneeelen.

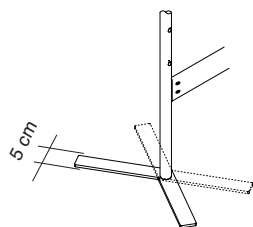

Dettaglio della base. La base può essere montata in due posizioni, interna o esterna.
Detail of the base. The base can be mounted in two positions, internal or external.

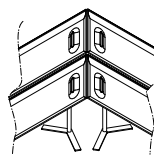

Nelle composizioni ad angolo, l'utilizzo di questa base permette il perfetto accostamento dei pannelli.
In the corner compositions the use of this base allows the perfect approaching of the panels.

MITESCO DIVIDER

design Michele De Lucchi
Snowsound® technology by Caimi Brevetti

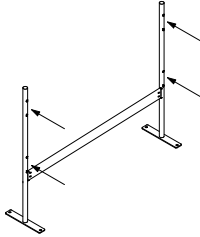
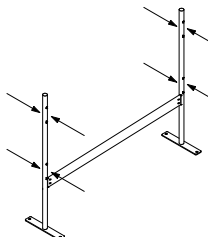
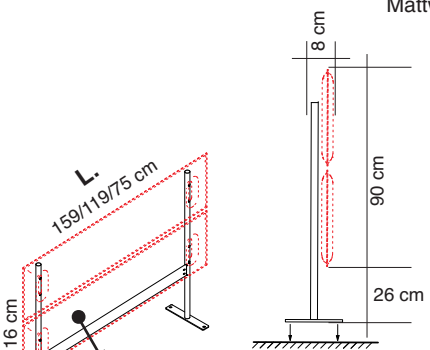
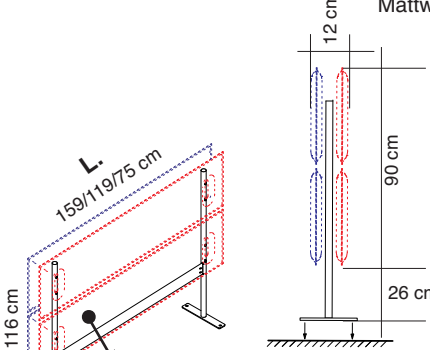
	Codice Code	Colore Colour	Prezzo Price		Codice Code	Colore Colour	Prezzo Price										
STRUTTURA MONOFRONTALE ONE-SIDED FRAME 	7M0625-GA	Grigio argento Silver grey Gris argenté Gris plata Silbergrau	Per pannelli For panels L. 159 cm	STRUTTURA BIFRONTALE DOUBLE-SIDED FRAME 	7M2625-GA	Grigio argento Silver grey Gris argenté Gris plata Silbergrau	Per pannelli For panels L. 159 cm										
	7M0625-BO	Bianco opaco Mat white Blanc mat Blanco mate Mattweiß	Per pannelli For panels L. 159 cm		7M2625-BO	Bianco opaco Mat white Blanc mat Blanco mate Mattweiß	Per pannelli For panels L. 159 cm										
	7M0225-GA	Grigio argento Silver grey Gris argenté Gris plata Silbergrau	Per pannelli For panels L. 119 cm		7M2225-GA	Grigio argento Silver grey Gris argenté Gris plata Silbergrau	Per pannelli For panels L. 119 cm										
	7M0225-BO	Bianco opaco Mat white Blanc mat Blanco mate Mattweiß	Per pannelli For panels L. 119 cm		7M2225-BO	Bianco opaco Mat white Blanc mat Blanco mate Mattweiß	Per pannelli For panels L. 119 cm										
	7M0825-GA	Grigio argento Silver grey Gris argenté Gris plata Silbergrau	Per pannelli For panels L. 75 cm		7M2825-GA	Grigio argento Silver grey Gris argenté Gris plata Silbergrau	Per pannelli For panels L. 75 cm										
	7M0825-BO	Bianco opaco Mat white Blanc mat Blanco mate Mattweiß	Per pannelli For panels L. 75 cm		7M2825-BO	Bianco opaco Mat white Blanc mat Blanco mate Mattweiß	Per pannelli For panels L. 75 cm										
		<table border="1"> <tr> <td>A</td> <td>7M1016-XXXX o/or 7M1016BO-XXXX</td> <td rowspan="2">L. 159 cm</td> </tr> <tr> <td>B</td> <td>7M0625-GA o/or 7M0625-BO</td> </tr> </table>			A	7M1016-XXXX o/or 7M1016BO-XXXX	L. 159 cm	B	7M0625-GA o/or 7M0625-BO		<table border="1"> <tr> <td>A</td> <td>7M1016-XXXX o/or 7M1016BO-XXXX</td> <td rowspan="2">L. 159 cm</td> </tr> <tr> <td>B</td> <td>7M2625-GA o/or 7M2625-BO</td> </tr> </table>		A	7M1016-XXXX o/or 7M1016BO-XXXX	L. 159 cm	B	7M2625-GA o/or 7M2625-BO
	A	7M1016-XXXX o/or 7M1016BO-XXXX	L. 159 cm														
	B	7M0625-GA o/or 7M0625-BO															
	A	7M1016-XXXX o/or 7M1016BO-XXXX	L. 159 cm														
B	7M2625-GA o/or 7M2625-BO																
o/or		o/or															
<table border="1"> <tr> <td>A</td> <td>7M1012-XXXX o/or 7M1012BO-XXXX</td> <td rowspan="2">L. 119 cm</td> </tr> <tr> <td>B</td> <td>7M0225-GA o/or 7M0225-BO</td> </tr> </table>		A	7M1012-XXXX o/or 7M1012BO-XXXX	L. 119 cm	B	7M0225-GA o/or 7M0225-BO	<table border="1"> <tr> <td>A</td> <td>7M1012-XXXX o/or 7M1012BO-XXXX</td> <td rowspan="2">L. 119 cm</td> </tr> <tr> <td>B</td> <td>7M2225-GA o/or 7M2225-BO</td> </tr> </table>		A	7M1012-XXXX o/or 7M1012BO-XXXX	L. 119 cm	B	7M2225-GA o/or 7M2225-BO				
A	7M1012-XXXX o/or 7M1012BO-XXXX	L. 119 cm															
B	7M0225-GA o/or 7M0225-BO																
A	7M1012-XXXX o/or 7M1012BO-XXXX	L. 119 cm															
B	7M2225-GA o/or 7M2225-BO																
o/or		o/or															
<table border="1"> <tr> <td>A</td> <td>7M1008-XXXX o/or 7M1008BO-XXXX</td> <td rowspan="2">L. 75 cm</td> </tr> <tr> <td>B</td> <td>7M0825-GA o/or 7M0825-BO</td> </tr> </table>		A	7M1008-XXXX o/or 7M1008BO-XXXX	L. 75 cm	B	7M0825-GA o/or 7M0825-BO	<table border="1"> <tr> <td>A</td> <td>7M1008-XXXX o/or 7M1008BO-XXXX</td> <td rowspan="2">L. 75 cm</td> </tr> <tr> <td>B</td> <td>7M2825-GA o/or 7M2825-BO</td> </tr> </table>		A	7M1008-XXXX o/or 7M1008BO-XXXX	L. 75 cm	B	7M2825-GA o/or 7M2825-BO				
A	7M1008-XXXX o/or 7M1008BO-XXXX	L. 75 cm															
B	7M0825-GA o/or 7M0825-BO																
A	7M1008-XXXX o/or 7M1008BO-XXXX	L. 75 cm															
B	7M2825-GA o/or 7M2825-BO																
o/or		o/or															

Struttura in acciaio verniciato con polveri epossidiche con basi in acciaio verniciato con polveri epossidiche per fissaggio a terra (viti non incluse) per il montaggio di 2 o 4 pannelli Mitesco.

Structure in powder-coated steel with powder-coated steel bases for floor fixing (screws not included), to mount 2 or 4 Mitesco panels.

Structure en acier peint époxy avec bases en acier peint époxy pour fixation au sol (vis pas incluses) pour le montage de 2 ou 4 panneaux Mitesco.

Estructura de acero recubierto epoxi con bases de acero recubierto epoxi para fijación al suelo (tornillos no incluidos) para el montaje de 2 o 4 paneles Mitesco.

Standssäulen aus pulverbeschichtetem Stahl mit Fuß zur Bodenbefestigung (Schrauben nicht inkludiert) aus pulverbeschichtetem Stahl zur Aufstellung von 2 oder 4 Mitesco-Paneele.

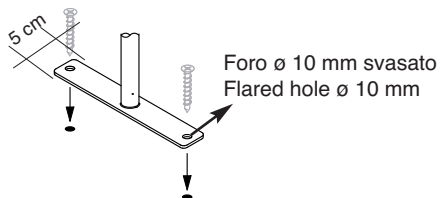

Foro ø 10 mm svasato
Flared hole ø 10 mm

Dettaglio della base (viti non incluse)
Detail of the base (screws not included)
Détail de la base (vis pas incluses)
Detalle de la base (tornillos no incluidos)
Details der Basis (Schrauben nicht inkludiert)

MITESCO DIVIDER

design Michele De Lucchi
Snowsound® technology by Caimi Brevetti

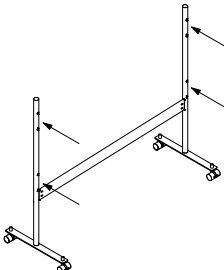
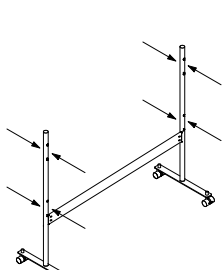
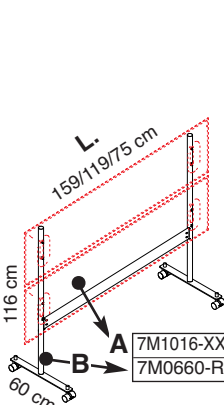
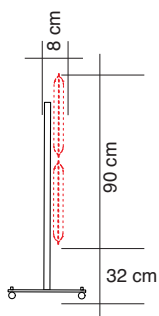
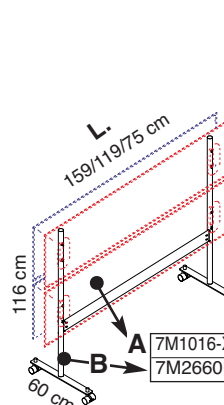
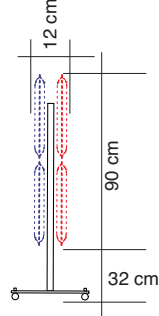
	Codice Code	Colore Colour	Prezzo Price		Codice Code	Colore Colour	Prezzo Price												
STRUTTURA MONOFRONTALE ONE-SIDED FRAME 	7M0660-RGA	Grigio argento Silver grey Gris argenté Gris plata Silbergrau	Per pannelli For panels L. 159 cm	STRUTTURA BIFRONTALE DOUBLE-SIDED FRAME 	7M2660-RGA	Grigio argento Silver grey Gris argenté Gris plata Silbergrau	Per pannelli For panels L. 159 cm												
	7M0660-RBO	Bianco opaco Mat white Blanc mat Blanco mate Mattweiß	Per pannelli For panels L. 159 cm		7M2660-RBO	Bianco opaco Mat white Blanc mat Blanco mate Mattweiß	Per pannelli For panels L. 159 cm												
	7M0260-RGA	Grigio argento Silver grey Gris argenté Gris plata Silbergrau	Per pannelli For panels L. 119 cm		7M2260-RGA	Grigio argento Silver grey Gris argenté Gris plata Silbergrau	Per pannelli For panels L. 119 cm												
	7M0260-RBO	Bianco opaco Mat white Blanc mat Blanco mate Mattweiß	Per pannelli For panels L. 119 cm		7M2260-RBO	Bianco opaco Mat white Blanc mat Blanco mate Mattweiß	Per pannelli For panels L. 119 cm												
	7M0860-RGA	Grigio argento Silver grey Gris argenté Gris plata Silbergrau	Per pannelli For panels L. 75 cm		7M2860-RGA	Grigio argento Silver grey Gris argenté Gris plata Silbergrau	Per pannelli For panels L. 75 cm												
	7M0860-RBO	Bianco opaco Mat white Blanc mat Blanco mate Mattweiß	Per pannelli For panels L. 75 cm		7M2860-RBO	Bianco opaco Mat white Blanc mat Blanco mate Mattweiß	Per pannelli For panels L. 75 cm												
																			
	<table border="1"> <tr> <td>A</td> <td>7M1016-XXXX o/or 7M1016BO-XXXX</td> <td rowspan="2">L. 159 cm</td> </tr> <tr> <td>B</td> <td>7M0660-RGA o/or 7M0660-RBO</td> </tr> </table>		A		7M1016-XXXX o/or 7M1016BO-XXXX	L. 159 cm	B	7M0660-RGA o/or 7M0660-RBO	o/or		<table border="1"> <tr> <td>A</td> <td>7M1016-XXXX o/or 7M1016BO-XXXX</td> <td rowspan="2">L. 159 cm</td> </tr> <tr> <td>B</td> <td>7M2660R-GA o/or 7M2660-RBO</td> </tr> </table>		A	7M1016-XXXX o/or 7M1016BO-XXXX	L. 159 cm	B	7M2660R-GA o/or 7M2660-RBO	o/or	
	A	7M1016-XXXX o/or 7M1016BO-XXXX	L. 159 cm																
	B	7M0660-RGA o/or 7M0660-RBO																	
A	7M1016-XXXX o/or 7M1016BO-XXXX	L. 159 cm																	
B	7M2660R-GA o/or 7M2660-RBO																		
<table border="1"> <tr> <td>A</td> <td>7M1012-XXXX o/or 7M1012BO-XXXX</td> <td rowspan="2">L. 119 cm</td> </tr> <tr> <td>B</td> <td>7M0260-RGA o/or 7M0260-RBO</td> </tr> </table>		A	7M1012-XXXX o/or 7M1012BO-XXXX	L. 119 cm	B	7M0260-RGA o/or 7M0260-RBO	o/or		<table border="1"> <tr> <td>A</td> <td>7M1012-XXXX o/or 7M1012BO-XXXX</td> <td rowspan="2">L. 119 cm</td> </tr> <tr> <td>B</td> <td>7M2260-RGA o/or 7M2260-RBO</td> </tr> </table>		A	7M1012-XXXX o/or 7M1012BO-XXXX	L. 119 cm	B	7M2260-RGA o/or 7M2260-RBO	o/or			
A	7M1012-XXXX o/or 7M1012BO-XXXX	L. 119 cm																	
B	7M0260-RGA o/or 7M0260-RBO																		
A	7M1012-XXXX o/or 7M1012BO-XXXX	L. 119 cm																	
B	7M2260-RGA o/or 7M2260-RBO																		
<table border="1"> <tr> <td>A</td> <td>7M1008-XXXX o/or 7M1008BO-XXXX</td> <td rowspan="2">L. 75 cm</td> </tr> <tr> <td>B</td> <td>7M0860-RGA o/or 7M0860-RBO</td> </tr> </table>		A	7M1008-XXXX o/or 7M1008BO-XXXX	L. 75 cm	B	7M0860-RGA o/or 7M0860-RBO	o/or		<table border="1"> <tr> <td>A</td> <td>7M1008-XXXX o/or 7M1008BO-XXXX</td> <td rowspan="2">L. 75 cm</td> </tr> <tr> <td>B</td> <td>7M2860-RGA o/or 7M2860-RBO</td> </tr> </table>		A	7M1008-XXXX o/or 7M1008BO-XXXX	L. 75 cm	B	7M2860-RGA o/or 7M2860-RBO	o/or			
A	7M1008-XXXX o/or 7M1008BO-XXXX	L. 75 cm																	
B	7M0860-RGA o/or 7M0860-RBO																		
A	7M1008-XXXX o/or 7M1008BO-XXXX	L. 75 cm																	
B	7M2860-RGA o/or 7M2860-RBO																		

Struttura in acciaio verniciato con polveri epossidiche con basi in acciaio verniciato con polveri epossidiche con ruote in tecnopolimero (2 con freno e 2 senza) per il montaggio di **2 o 4** pannelli Mitesco.

Structure in powder-coated steel with powder-coated steel bases with high-tech polymer castors (2 with and 2 without brakes), to mount **2 or 4** Mitesco panels.

Structure en acier peint époxy avec bases en acier peint époxy et roulettes en technopolymère (2 avec freins et 2 sans) pour le montage de **2 ou 4** panneaux Mitesco.

Estructura de acero recubierto epoxi con bases de acero recubierto epoxi con ruedasde polimero (2 con freno y 2 sin) para el montaje de **2 o 4** paneles Mitesco.

Standssäulen aus pulverbeschichtetem Stahl mit Standfuß aus pulverbeschichtetem Stahl mit Rollen aus Technopolymer (2 davon feststellbar) zur Aufstellung von **2 oder 4** Mitesco-Paneeelen.

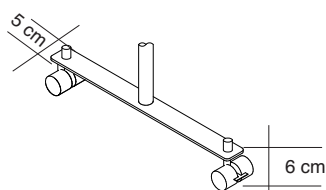

Dettaglio della base
Detail of the base
Détail de la base
Detaille de la base
Details der Basis

MITESCO DIVIDER

design Michele De Lucchi
Snowsound® technology by Caimi Brevetti

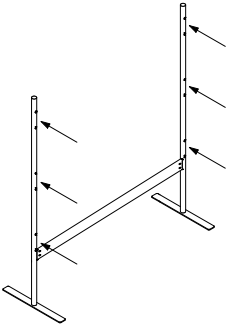
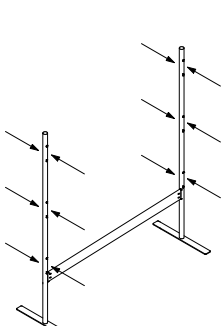
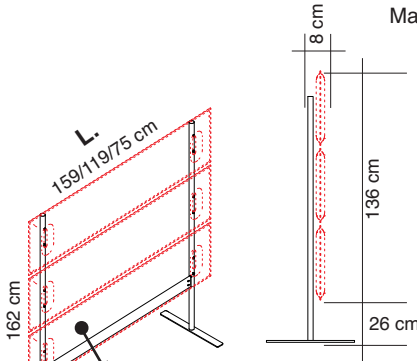
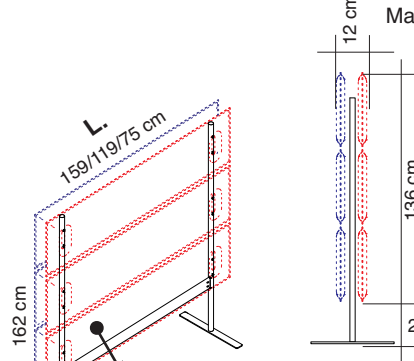
	Codice Code	Colore Colour	Prezzo Price		Codice Code	Colore Colour	Prezzo Price
STRUTTURA MONOFRONTE ONE-SIDED FRAME 	7M3650-GA	Grigio argento Silver grey Gris argenté Gris plata Silbergrau	Per pannelli For panels L. 159 cm	STRUTTURA BIFRONTE DOUBLE-SIDED FRAME 	7M6650-GA	Grigio argento Silver grey Gris argenté Gris plata Silbergrau	Per pannelli For panels L. 159 cm
	7M3650-BO	Bianco opaco Mat white Blanc mat Blanco mate Mattweiß	Per pannelli For panels L. 159 cm		7M6650-BO	Bianco opaco Mat white Blanc mat Blanco mate Mattweiß	Per pannelli For panels L. 159 cm
	7M3250-GA	Grigio argento Silver grey Gris argenté Gris plata Silbergrau	Per pannelli For panels L. 119 cm		7M6250-GA	Grigio argento Silver grey Gris argenté Gris plata Silbergrau	Per pannelli For panels L. 119 cm
	7M3250-BO	Bianco opaco Mat white Blanc mat Blanco mate Mattweiß	Per pannelli For panels L. 119 cm		7M6250-BO	Bianco opaco Mat white Blanc mat Blanco mate Mattweiß	Per pannelli For panels L. 119 cm
	7M3850-GA	Grigio argento Silver grey Gris argenté Gris plata Silbergrau	Per pannelli For panels L. 75 cm		7M6850-GA	Grigio argento Silver grey Gris argenté Gris plata Silbergrau	Per pannelli For panels L. 75 cm
	7M3850-BO	Bianco opaco Mat white Blanc mat Blanco mate Mattweiß	Per pannelli For panels L. 75 cm		7M6850-BO	Bianco opaco Mat white Blanc mat Blanco mate Mattweiß	Per pannelli For panels L. 75 cm
		A 7M1016-XXXX o/or 7M1016BO-XXXX B 7M3650-GA o/or 7M3650-BO	L. 159 cm			A 7M1016-XXXX o/or 7M1016BO-XXXX B 7M6650-GA o/or 7M6650-BO	L. 159 cm
	A 7M1012-XXXX o/or 7M1012BO-XXXX B 7M3250-GA o/or 7M3250-BO	L. 119 cm	A 7M1012-XXXX o/or 7M1012BO-XXXX B 7M6250-GA o/or 7M6250-BO		L. 119 cm		
	A 7M1008-XXXX o/or 7M1008BO-XXXX B 7M3850-GA o/or 7M3850-BO	L. 75 cm	A 7M1008-XXXX o/or 7M1008BO-XXXX B 7M6850-GA o/or 7M6850-BO		L. 75 cm		

Struttura in acciaio verniciato con polveri epossidiche con basi in acciaio verniciato con polveri epossidiche per il montaggio di **3 o 6** pannelli Mitesco.

Structure in powder-coated steel with bases in powder-coated steel to mount **3 ou 6** Mitesco panels.

Structure en acier peint époxy avec bases en acier peint époxy pour le montage de **3 ou 6** panneaux Mitesco.

Estructura de acero recubierto epoxi con bases de acero recubierto epoxi para el montaje de **3 o 6** paneles Mitesco.

Standssäulen aus pulverbeschichtetem Stahl mit Standfuß aus pulverbeschichtetem Stahl zur Aufstellung von **3 oder 6** Mitesco-Paneeelen.

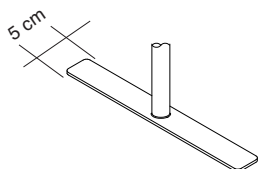

Dettaglio della base
Detail of the base
Détail de la base
Detalle de la base
Details der Basis

MITESCO DIVIDER

design Michele De Lucchi
Snowsound® technology by Caimi Brevetti

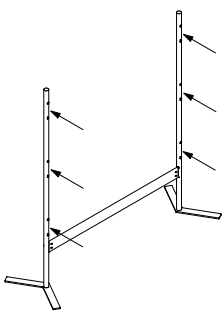
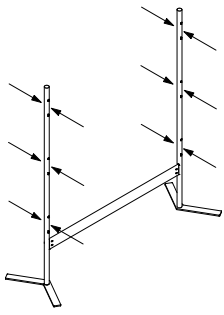
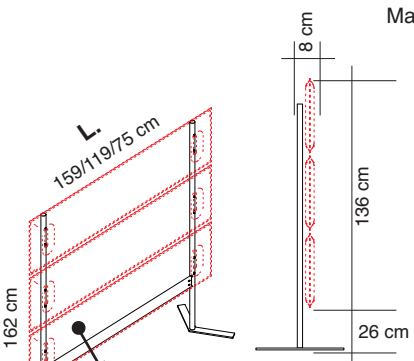
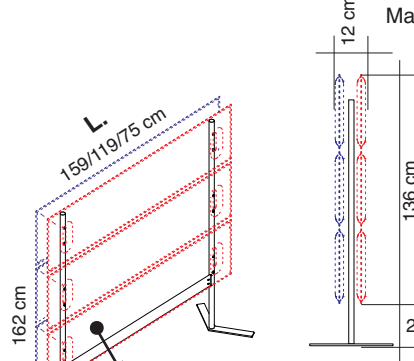
	Codice Code	Colore Colour	Prezzo Price		Codice Code	Colore Colour	Prezzo Price																																												
STRUTTURA MONOFRONTA ONE-SIDED FRAME 	7M3630-GA	Grigio argento Silver grey Gris argenté Gris plata Silbergrau	Per pannelli For panels L. 159 cm	STRUTTURA BIFRONTA DOUBLE-SIDED FRAME 	7M6630-GA	Grigio argento Silver grey Gris argenté Gris plata Silbergrau	Per pannelli For panels L. 159 cm																																												
	7M3630-BO	Bianco opaco Mat white Blanc mat Blanco mate Mattweiß	Per pannelli For panels L. 159 cm		7M6630-BO	Bianco opaco Mat white Blanc mat Blanco mate Mattweiß	Per pannelli For panels L. 159 cm																																												
	7M3230-GA	Grigio argento Silver grey Gris argenté Gris plata Silbergrau	Per pannelli For panels L. 119 cm		7M6230-GA	Grigio argento Silver grey Gris argenté Gris plata Silbergrau	Per pannelli For panels L. 119 cm																																												
	7M3230-BO	Bianco opaco Mat white Blanc mat Blanco mate Mattweiß	Per pannelli For panels L. 119 cm		7M6230-BO	Bianco opaco Mat white Blanc mat Blanco mate Mattweiß	Per pannelli For panels L. 119 cm																																												
	7M3830-GA	Grigio argento Silver grey Gris argenté Gris plata Silbergrau	Per pannelli For panels L. 75 cm		7M6830-GA	Grigio argento Silver grey Gris argenté Gris plata Silbergrau	Per pannelli For panels L. 75 cm																																												
	7M3830-BO	Bianco opaco Mat white Blanc mat Blanco mate Mattweiß	Per pannelli For panels L. 75 cm		7M6830-BO	Bianco opaco Mat white Blanc mat Blanco mate Mattweiß	Per pannelli For panels L. 75 cm																																												
			<table border="1"> <tr> <td>A</td> <td>7M1016-XXXX o/or 7M1016BO-XXXX</td> <td rowspan="2">L. 159 cm</td> </tr> <tr> <td>B</td> <td>7M3630-GA o/or 7M3630-BO</td> </tr> <tr> <td colspan="3" style="text-align: center;">o/or</td> </tr> <tr> <td>A</td> <td>7M1012-XXXX o/or 7M1012BO-XXXX</td> <td rowspan="2">L. 119 cm</td> </tr> <tr> <td>B</td> <td>7M3230-GA o/or 7M3230-BO</td> </tr> <tr> <td colspan="3" style="text-align: center;">o/or</td> </tr> <tr> <td>A</td> <td>7M1008-XXXX o/or 7M1008BO-XXXX</td> <td rowspan="2">L. 75 cm</td> </tr> <tr> <td>B</td> <td>7M3830-GA o/or 7M3830-BO</td> </tr> </table>		A	7M1016-XXXX o/or 7M1016BO-XXXX	L. 159 cm	B	7M3630-GA o/or 7M3630-BO	o/or			A	7M1012-XXXX o/or 7M1012BO-XXXX	L. 119 cm	B	7M3230-GA o/or 7M3230-BO	o/or			A	7M1008-XXXX o/or 7M1008BO-XXXX	L. 75 cm	B	7M3830-GA o/or 7M3830-BO			<table border="1"> <tr> <td>A</td> <td>7M1016-XXXX o/or 7M1016BO-XXXX</td> <td rowspan="2">L. 159 cm</td> </tr> <tr> <td>B</td> <td>7M6630-GA o/or 7M6630-BO</td> </tr> <tr> <td colspan="3" style="text-align: center;">o/or</td> </tr> <tr> <td>A</td> <td>7M1012-XXXX o/or 7M1012BO-XXXX</td> <td rowspan="2">L. 119 cm</td> </tr> <tr> <td>B</td> <td>7M6230-GA o/or 7M6230-BO</td> </tr> <tr> <td colspan="3" style="text-align: center;">o/or</td> </tr> <tr> <td>A</td> <td>7M1008-XXXX o/or 7M1008BO-XXXX</td> <td rowspan="2">L. 75 cm</td> </tr> <tr> <td>B</td> <td>7M6830-GA o/or 7M6830-BO</td> </tr> </table>		A	7M1016-XXXX o/or 7M1016BO-XXXX	L. 159 cm	B	7M6630-GA o/or 7M6630-BO	o/or			A	7M1012-XXXX o/or 7M1012BO-XXXX	L. 119 cm	B	7M6230-GA o/or 7M6230-BO	o/or			A	7M1008-XXXX o/or 7M1008BO-XXXX	L. 75 cm	B	7M6830-GA o/or 7M6830-BO	
	A	7M1016-XXXX o/or 7M1016BO-XXXX	L. 159 cm																																																
	B	7M3630-GA o/or 7M3630-BO																																																	
	o/or																																																		
A	7M1012-XXXX o/or 7M1012BO-XXXX	L. 119 cm																																																	
B	7M3230-GA o/or 7M3230-BO																																																		
o/or																																																			
A	7M1008-XXXX o/or 7M1008BO-XXXX	L. 75 cm																																																	
B	7M3830-GA o/or 7M3830-BO																																																		
A	7M1016-XXXX o/or 7M1016BO-XXXX	L. 159 cm																																																	
B	7M6630-GA o/or 7M6630-BO																																																		
o/or																																																			
A	7M1012-XXXX o/or 7M1012BO-XXXX	L. 119 cm																																																	
B	7M6230-GA o/or 7M6230-BO																																																		
o/or																																																			
A	7M1008-XXXX o/or 7M1008BO-XXXX	L. 75 cm																																																	
B	7M6830-GA o/or 7M6830-BO																																																		

Struttura in acciaio verniciato con polveri epossidiche con basi in acciaio verniciato con polveri epossidiche per il montaggio di 3 o 6 pannelli Mitesco.

Structure in powder-coated steel with bases in powder-coated steel to mount 3 or 6 Mitesco panels.

Structure en acier peint époxy avec bases en acier peint époxy pour le montage de 3 ou 6 panneaux Mitesco.

Estructura de acero recubierto epoxi con bases de acero recubierto epoxi para el montaje de 3 o 6 paneles Mitesco.

Standssäulen aus pulverbeschichtetem Stahl mit Standfuß aus pulverbeschichtetem Stahl zur Aufstellung von 3 oder 6 Mitesco-Paneele.

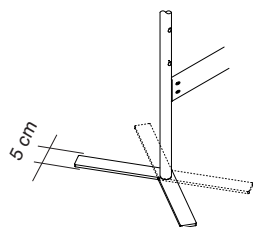

Dettaglio della base. La base può essere montata in due posizioni, interna o esterna.
Detail of the base. The base can be mounted in two positions, internal or external.

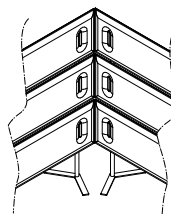

Nelle composizioni ad angolo, l'utilizzo di questa base permette il perfetto accostamento dei pannelli.
In the corner compositions the use of this base allows the perfect approaching of the panels.

MITESCO DIVIDER

design Michele De Lucchi
Snowsound® technology by Caimi Brevetti

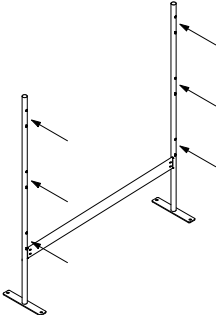
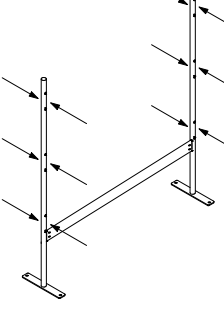
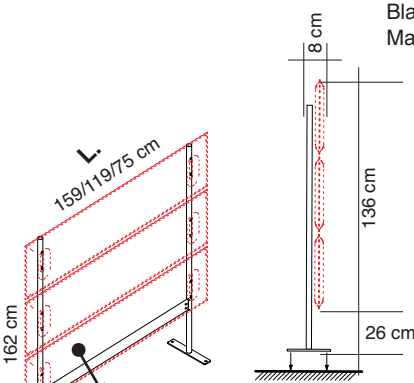
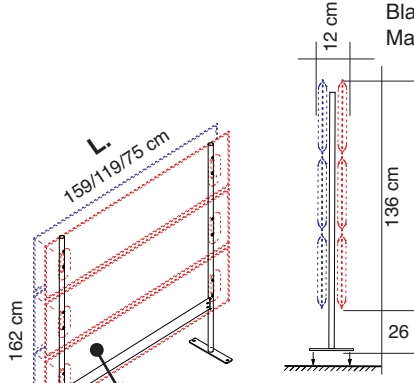
	Codice Code	Colore Colour	Prezzo Price		Codice Code	Colore Colour	Prezzo Price								
STRUTTURA MONOFRONTALE ONE-SIDED FRAME 	7M3625-GA	Grigio argento Silver grey Gris argenté Gris plata Silbergrau	Per pannelli For panels L. 159 cm	STRUTTURA BIFRONTALE DOUBLE-SIDED FRAME 	7M6625-GA	Grigio argento Silver grey Gris argenté Gris plata Silbergrau	Per pannelli For panels L. 159 cm								
	7M3625-BO	Bianco opaco Mat white Blanc mat Blanco mate Mattweiß	Per pannelli For panels L. 159 cm		7M6625-BO	Bianco opaco Mat white Blanc mat Blanco mate Mattweiß	Per pannelli For panels L. 159 cm								
	7M3225-GA	Grigio argento Silver grey Gris argenté Gris plata Silbergrau	Per pannelli For panels L. 119 cm		7M6225-GA	Grigio argento Silver grey Gris argenté Gris plata Silbergrau	Per pannelli For panels L. 119 cm								
	7M3225-BO	Bianco opaco Mat white Blanc mat Blanco mate Mattweiß	Per pannelli For panels L. 119 cm		7M6225-BO	Bianco opaco Mat white Blanc mat Blanco mate Mattweiß	Per pannelli For panels L. 119 cm								
	7M3825-GA	Grigio argento Silver grey Gris argenté Gris plata Silbergrau	Per pannelli For panels L. 75 cm		7M6825-GA	Grigio argento Silver grey Gris argenté Gris plata Silbergrau	Per pannelli For panels L. 75 cm								
	7M3825-BO	Bianco opaco Mat white Blanc mat Blanco mate Mattweiß	Per pannelli For panels L. 75 cm		7M6825-BO	Bianco opaco Mat white Blanc mat Blanco mate Mattweiß	Per pannelli For panels L. 75 cm								
															
	<table border="1"> <tr> <td>A</td> <td>7M1016-XXXX o/or 7M1016BO-XXXX</td> <td rowspan="2">L. 159 cm</td> </tr> <tr> <td>B</td> <td>7M3625-GA o/or 7M3625-BO</td> </tr> </table>		A		7M1016-XXXX o/or 7M1016BO-XXXX	L. 159 cm	B	7M3625-GA o/or 7M3625-BO	<table border="1"> <tr> <td>A</td> <td>7M1016-XXXX o/or 7M1016BO-XXXX</td> <td rowspan="2">L. 159 cm</td> </tr> <tr> <td>B</td> <td>7M6625-GA o/or 7M6625-BO</td> </tr> </table>		A	7M1016-XXXX o/or 7M1016BO-XXXX	L. 159 cm	B	7M6625-GA o/or 7M6625-BO
	A	7M1016-XXXX o/or 7M1016BO-XXXX	L. 159 cm												
	B	7M3625-GA o/or 7M3625-BO													
A	7M1016-XXXX o/or 7M1016BO-XXXX	L. 159 cm													
B	7M6625-GA o/or 7M6625-BO														
<table border="1"> <tr> <td>A</td> <td>7M1012-XXXX o/or 7M1012BO-XXXX</td> <td rowspan="2">L. 119 cm</td> </tr> <tr> <td>B</td> <td>7M3225-GA o/or 7M3225-BO</td> </tr> </table>		A	7M1012-XXXX o/or 7M1012BO-XXXX	L. 119 cm	B	7M3225-GA o/or 7M3225-BO	<table border="1"> <tr> <td>A</td> <td>7M1012-XXXX o/or 7M1012BO-XXXX</td> <td rowspan="2">L. 119 cm</td> </tr> <tr> <td>B</td> <td>7M6225-GA o/or 7M6225-BO</td> </tr> </table>		A	7M1012-XXXX o/or 7M1012BO-XXXX	L. 119 cm	B	7M6225-GA o/or 7M6225-BO		
A	7M1012-XXXX o/or 7M1012BO-XXXX	L. 119 cm													
B	7M3225-GA o/or 7M3225-BO														
A	7M1012-XXXX o/or 7M1012BO-XXXX	L. 119 cm													
B	7M6225-GA o/or 7M6225-BO														
<table border="1"> <tr> <td>A</td> <td>7M1008-XXXX o/or 7M1008BO-XXXX</td> <td rowspan="2">L. 75 cm</td> </tr> <tr> <td>B</td> <td>7M3825-GA o/or 7M3825-BO</td> </tr> </table>		A	7M1008-XXXX o/or 7M1008BO-XXXX	L. 75 cm	B	7M3825-GA o/or 7M3825-BO	<table border="1"> <tr> <td>A</td> <td>7M1008-XXXX o/or 7M1008BO-XXXX</td> <td rowspan="2">L. 75 cm</td> </tr> <tr> <td>B</td> <td>7M6825-GA o/or 7M6825-BO</td> </tr> </table>		A	7M1008-XXXX o/or 7M1008BO-XXXX	L. 75 cm	B	7M6825-GA o/or 7M6825-BO		
A	7M1008-XXXX o/or 7M1008BO-XXXX	L. 75 cm													
B	7M3825-GA o/or 7M3825-BO														
A	7M1008-XXXX o/or 7M1008BO-XXXX	L. 75 cm													
B	7M6825-GA o/or 7M6825-BO														

Struttura in acciaio verniciato con polveri epossidiche con basi in acciaio verniciato con polveri epossidiche per fissaggio a terra (viti non incluse) per il montaggio di **3 o 6** pannelli Mitesco.

Structure in powder-coated steel with powder-coated steel bases for floor fixing (screws not included), to mount **3 or 6** Mitesco panels.

Structure en acier peint époxy avec bases en acier peint époxy pour fixation au sol (vis pas incluses) pour le montage de **3 ou 6** panneaux Mitesco.

Estructura de acero recubierto epoxi con bases de acero recubierto epoxi para fijación al suelo (tornillos no incluidos) para el montaje de **3 o 6** paneles Mitesco.

Standssäulen aus pulverbeschichtetem Stahl mit Fuß zur Bodenbefestigung (Schrauben nicht inkludiert) aus pulverbeschichtetem Stahl zur Aufstellung von **3 oder 6** Mitesco-Paneele.

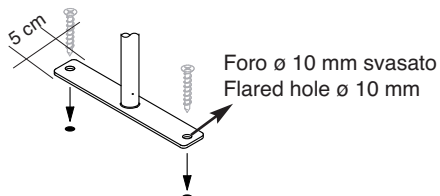

Foro ø 10 mm svasato
Flared hole ø 10 mm

Dettaglio della base (viti non incluse)
Detail of the base (screws not included)
Détail de la base (vis pas incluses)
Detalle de la base (tornillos no incluidos)
Details der Basis (Schrauben nicht inkludiert)

MITESCO DIVIDER

design Michele De Lucchi
Snowsound® technology by Caimi Brevetti

	Codice Code	Colore Colour	Prezzo Price
STRUTTURA MONOFRONTALE ONE-SIDED FRAME	7M3660-RGA	Grigio argento Silver grey Gris argenté Gris plata Silbergrau	Per pannelli For panels L. 159 cm
	7M3660-RBO	Bianco opaco Mat white Blanc mat Blanco mate Mattweiß	Per pannelli For panels L. 159 cm
	7M3260-RGA	Grigio argento Silver grey Gris argenté Gris plata Silbergrau	Per pannelli For panels L. 119 cm
	7M3260-RBO	Bianco opaco Mat white Blanc mat Blanco mate Mattweiß	Per pannelli For panels L. 119 cm
	7M3860-RGA	Grigio argento Silver grey Gris argenté Gris plata Silbergrau	Per pannelli For panels L. 75 cm
	7M3860-RBO	Bianco opaco Mat white Blanc mat Blanco mate Mattweiß	Per pannelli For panels L. 75 cm

A	7M1016-XXXX o/or 7M1016BO-XXXX	L. 159 cm
B	7M3660-RGA o/or 7M3660-RBO	
o/or		
A	7M1012-XXXX o/or 7M1012BO-XXXX	L. 119 cm
B	7M3260-RGA o/or 7M3260-RBO	
o/or		
A	7M1008-XXXX o/or 7M1008BO-XXXX	L. 75 cm
B	7M3860-RGA o/or 7M3860-RBO	

	Codice Code	Colore Colour	Prezzo Price
STRUTTURA BIFRONTALE DOUBLE-SIDED FRAME	7M6660-RGA	Grigio argento Silver grey Gris argenté Gris plata Silbergrau	Per pannelli For panels L. 159 cm
	7M6660-RBO	Bianco opaco Mat white Blanc mat Blanco mate Mattweiß	Per pannelli For panels L. 159 cm
	7M6260-RGA	Grigio argento Silver grey Gris argenté Gris plata Silbergrau	Per pannelli For panels L. 119 cm
	7M6260-RBO	Bianco opaco Mat white Blanc mat Blanco mate Mattweiß	Per pannelli For panels L. 119 cm
	7M6860-RGA	Grigio argento Silver grey Gris argenté Gris plata Silbergrau	Per pannelli For panels L. 75 cm
	7M6860-RBO	Bianco opaco Mat white Blanc mat Blanco mate Mattweiß	Per pannelli For panels L. 75 cm

A	7M1016-XXXX o/or 7M1016BO-XXXX	L. 159 cm
B	7M6660R-GA o/or 7M6660-RBO	
o/or		
A	7M1012-XXXX o/or 7M1012BO-XXXX	L. 119 cm
B	7M6260-RGA o/or 7M6260-RBO	
o/or		
A	7M1008-XXXX o/or 7M1008BO-XXXX	L. 75 cm
B	7M6860-RGA o/or 7M6860-RBO	

Struttura in acciaio verniciato con polveri epossidiche con basi in acciaio verniciato con polveri epossidiche con ruote in tecnopolimero (2 con freno e 2 senza) per il montaggio di **3 o 6** pannelli Mitesco.

Structure in powder-coated steel with powder-coated steel bases with high-tech polymer castors (2 with and 2 without brakes), to mount **3 or 6** Mitesco panels.

Structure en acier peint époxy avec bases en acier peint époxy et roulettes en technopolymère (2 avec freins et 2 sans) pour le montage de **3 ou 6** panneaux Mitesco.

Estructura de acero recubierto epoxi con bases de acero recubierto epoxi con ruedas en polimero (2 con freno y 2 sin) para el montaje de **3 o 6** paneles Mitesco.

Standssäulen aus pulverbeschichtetem Stahl mit Standfuß aus pulverbeschichtetem Stahl mit Rollen aus Technopolymer (2 davon feststellbar) zur Aufstellung von **3 oder 6** Mitesco-Paneeelen.

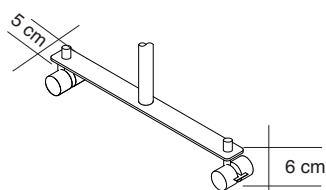

Dettaglio della base
Detail of the base
Détail de la base
Detaille de la base
Details der Basis

MITESCO DIVIDER

design Michele De Lucchi
Snowsound® technology by Caimi Brevetti

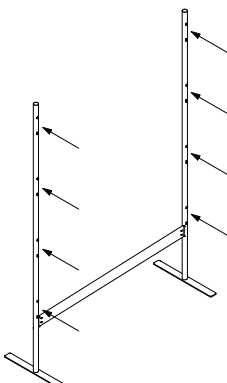
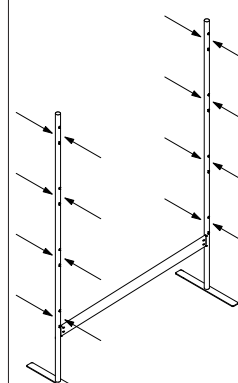
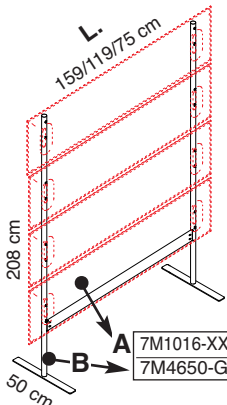
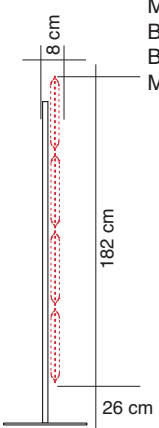
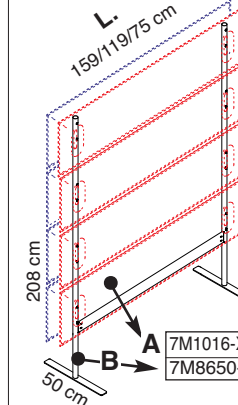
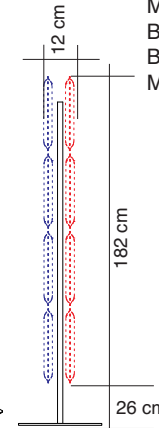
	Codice Code	Colore Colour	Prezzo Price		Codice Code	Colore Colour	Prezzo Price										
STRUTTURA MONOFRONTA ONE-SIDED FRAME 	7M4650-GA	Grigio argento Silver grey Gris argenté Gris plata Silbergrau	Per pannelli For panels L. 159 cm		7M8650-GA	Grigio argento Silver grey Gris argenté Gris plata Silbergrau	Per pannelli For panels L. 159 cm										
	7M4650-BO	Bianco opaco Mat white Blanc mat Blanco mate Mattweiß	Per pannelli For panels L. 159 cm		7M8650-BO	Bianco opaco Mat white Blanc mat Blanco mate Mattweiß	Per pannelli For panels L. 159 cm										
	7M4250-GA	Grigio argento Silver grey Gris argenté Gris plata Silbergrau	Per pannelli For panels L. 119 cm		7M8250-GA	Grigio argento Silver grey Gris argenté Gris plata Silbergrau	Per pannelli For panels L. 119 cm										
	7M4250-BO	Bianco opaco Mat white Blanc mat Blanco mate Mattweiß	Per pannelli For panels L. 119 cm		7M8250-BO	Bianco opaco Mat white Blanc mat Blanco mate Mattweiß	Per pannelli For panels L. 119 cm										
	7M4850-GA	Grigio argento Silver grey Gris argenté Gris plata Silbergrau	Per pannelli For panels L. 75 cm		7M8850-GA	Grigio argento Silver grey Gris argenté Gris plata Silbergrau	Per pannelli For panels L. 75 cm										
	7M4850-BO	Bianco opaco Mat white Blanc mat Blanco mate Mattweiß	Per pannelli For panels L. 75 cm		7M8850-BO	Bianco opaco Mat white Blanc mat Blanco mate Mattweiß	Per pannelli For panels L. 75 cm										
																	
	<table border="1"> <tr> <td>A</td> <td>7M1016-XXXX o/or 7M1016BO-XXXX</td> <td rowspan="2">L. 159 cm</td> </tr> <tr> <td>B</td> <td>7M4650-GA o/or 7M4650-BO</td> </tr> </table>		A		7M1016-XXXX o/or 7M1016BO-XXXX	L. 159 cm	B	7M4650-GA o/or 7M4650-BO	o/or		<table border="1"> <tr> <td>A</td> <td>7M1016-XXXX o/or 7M1016BO-XXXX</td> <td rowspan="2">L. 159 cm</td> </tr> <tr> <td>B</td> <td>7M8650-GA o/or 7M8650-BO</td> </tr> </table>		A	7M1016-XXXX o/or 7M1016BO-XXXX	L. 159 cm	B	7M8650-GA o/or 7M8650-BO
	A	7M1016-XXXX o/or 7M1016BO-XXXX	L. 159 cm														
	B	7M4650-GA o/or 7M4650-BO															
A	7M1016-XXXX o/or 7M1016BO-XXXX	L. 159 cm															
B	7M8650-GA o/or 7M8650-BO																
<table border="1"> <tr> <td>A</td> <td>7M1012-XXXX o/or 7M1012BO-XXXX</td> <td rowspan="2">L. 119 cm</td> </tr> <tr> <td>B</td> <td>7M4250-GA o/or 7M4250-BO</td> </tr> </table>		A	7M1012-XXXX o/or 7M1012BO-XXXX	L. 119 cm	B	7M4250-GA o/or 7M4250-BO	o/or		<table border="1"> <tr> <td>A</td> <td>7M1012-XXXX o/or 7M1012BO-XXXX</td> <td rowspan="2">L. 119 cm</td> </tr> <tr> <td>B</td> <td>7M8250-GA o/or 7M8250-BO</td> </tr> </table>		A	7M1012-XXXX o/or 7M1012BO-XXXX	L. 119 cm	B	7M8250-GA o/or 7M8250-BO		
A	7M1012-XXXX o/or 7M1012BO-XXXX	L. 119 cm															
B	7M4250-GA o/or 7M4250-BO																
A	7M1012-XXXX o/or 7M1012BO-XXXX	L. 119 cm															
B	7M8250-GA o/or 7M8250-BO																
<table border="1"> <tr> <td>A</td> <td>7M1008-XXXX o/or 7M1008BO-XXXX</td> <td rowspan="2">L. 75 cm</td> </tr> <tr> <td>B</td> <td>7M4850-GA o/or 7M4850-BO</td> </tr> </table>		A	7M1008-XXXX o/or 7M1008BO-XXXX	L. 75 cm	B	7M4850-GA o/or 7M4850-BO	o/or		<table border="1"> <tr> <td>A</td> <td>7M1008-XXXX o/or 7M1008BO-XXXX</td> <td rowspan="2">L. 75 cm</td> </tr> <tr> <td>B</td> <td>7M8850-GA o/or 7M8850-BO</td> </tr> </table>		A	7M1008-XXXX o/or 7M1008BO-XXXX	L. 75 cm	B	7M8850-GA o/or 7M8850-BO		
A	7M1008-XXXX o/or 7M1008BO-XXXX	L. 75 cm															
B	7M4850-GA o/or 7M4850-BO																
A	7M1008-XXXX o/or 7M1008BO-XXXX	L. 75 cm															
B	7M8850-GA o/or 7M8850-BO																

Struttura in acciaio verniciato con polveri epossidiche con basi in acciaio verniciato con polveri epossidiche per il montaggio di 4 o 8 pannelli Mitesco.

Structure in powder-coated steel with bases in powder-coated steel to mount 4 ou 8 Mitesco panels.

Structure en acier peint époxy avec bases en acier peint époxy pour le montage de 4 ou 8 panneaux Mitesco.

Estructura de acero recubierto epoxi con bases de acero recubierto epoxi para el montaje de 4 o 8 paneles Mitesco.



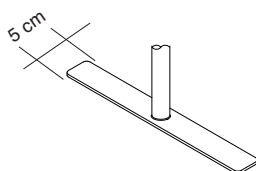

Standsäulen aus pulverbeschichtetem Stahl mit Standfuß aus pulverbeschichtetem Stahl zur Aufstellung von 4 oder 8 Mitesco-Paneele.

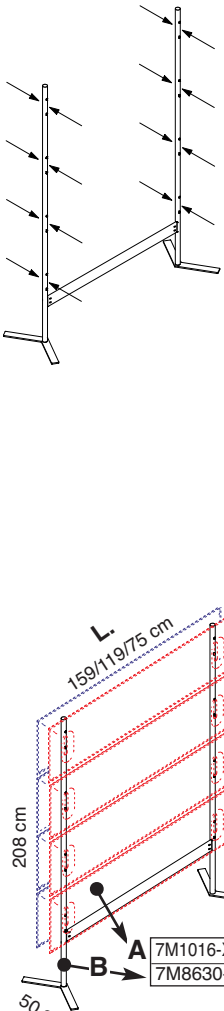

Dettaglio della base
Detail of the base
Détail de la base
Detalle de la base
Details der Basis

MITESCO DIVIDER

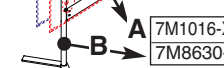
design Michele De Lucchi
Snowsound® technology by Caimi Brevetti

	Codice Code	Colore Colour	Prezzo Price		Codice Code	Colore Colour	Prezzo Price
STRUTTURA MONOFRONTE ONE-SIDED FRAME 	7M4630-GA	Grigio argento Silver grey Gris argenté Gris plata Silbergrau	Per pannelli For panels L. 159 cm	STRUTTURA BIFRONTE DOUBLE-SIDED FRAME 	7M8630-GA	Grigio argento Silver grey Gris argenté Gris plata Silbergrau	Per pannelli For panels L. 159 cm
	7M4630-BO	Bianco opaco Mat white Blanc mat Blanco mate Mattweiß	Per pannelli For panels L. 159 cm		7M8630-BO	Bianco opaco Mat white Blanc mat Blanco mate Mattweiß	Per pannelli For panels L. 159 cm
	7M4230-GA	Grigio argento Silver grey Gris argenté Gris plata Silbergrau	Per pannelli For panels L. 119 cm		7M8230-GA	Grigio argento Silver grey Gris argenté Gris plata Silbergrau	Per pannelli For panels L. 119 cm
	7M4230-BO	Bianco opaco Mat white Blanc mat Blanco mate Mattweiß	Per pannelli For panels L. 119 cm		7M8230-BO	Bianco opaco Mat white Blanc mat Blanco mate Mattweiß	Per pannelli For panels L. 119 cm
	7M4830-GA	Grigio argento Silver grey Gris argenté Gris plata Silbergrau	Per pannelli For panels L. 75 cm		7M8830-GA	Grigio argento Silver grey Gris argenté Gris plata Silbergrau	Per pannelli For panels L. 75 cm
	7M4830-BO	Bianco opaco Mat white Blanc mat Blanco mate Mattweiß	Per pannelli For panels L. 75 cm		7M8830-BO	Bianco opaco Mat white Blanc mat Blanco mate Mattweiß	Per pannelli For panels L. 75 cm
			L. 159 cm				L. 159 cm
			L. 159 cm				L. 159 cm
	A 7M1012-XXXX o/or 7M1012BO-XXXX B 7M4230-GA o/or 7M4230-BO		L. 119 cm		A 7M1012-XXXX o/or 7M1012BO-XXXX B 7M8230-GA o/or 7M8230-BO		L. 119 cm
	A 7M1008-XXXX o/or 7M1008BO-XXXX B 7M4830-GA o/or 7M4830-BO		L. 75 cm		A 7M1008-XXXX o/or 7M1008BO-XXXX B 7M8830-GA o/or 7M8830-BO		L. 75 cm

Struttura in acciaio verniciato con polveri epossidiche con basi in acciaio verniciato con polveri epossidiche per il montaggio di 4 o 8 pannelli Mitesco.

Structure in powder-coated steel with powder-coated steel bases, to mount 4 or 8 Mitesco panels.

Structure en acier peint époxy avec bases en acier peint époxy pour le montage de 4 ou 8 panneaux Mitesco.

Estructura de acero recubierto epoxi con bases de acero recubierto epoxi para el montaje de 4 o 8 paneles Mitesco.

Standsäulen aus pulverbeschichtetem Stahl mit Fuß aus pulverbeschichtetem Stahl zur Aufstellung von 4 oder 8 Mitesco-Paneelen.

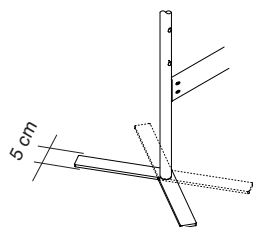

Dettaglio della base. La base può essere montata in due posizioni, interna o esterna.
Detail of the base. The base can be mounted in two positions, internal or external.

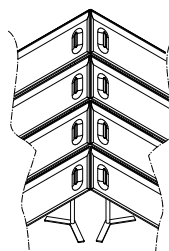

Nelle composizioni ad angolo, l'utilizzo di questa base permette il perfetto accostamento dei pannelli.
In the corner compositions the use of this base allows the perfect approaching of the panels.

MITESCO DIVIDER

design Michele De Lucchi
Snowsound® technology by Caimi Brevetti

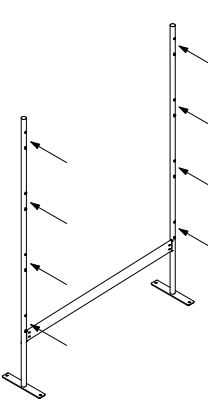
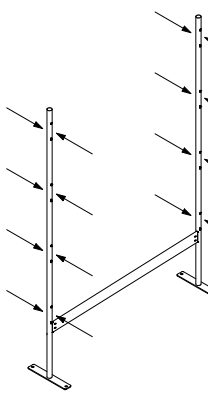
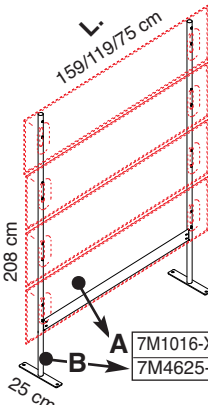
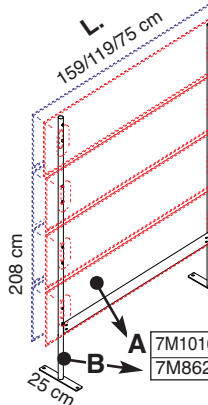
	Codice Code	Colore Colour	Prezzo Price		Codice Code	Colore Colour	Prezzo Price	
STRUTTURA MONOFRONTALE ONE-SIDED FRAME 	7M4625-GA	Grigio argento Silver grey Gris argenté Gris plata Silbergrau	Per pannelli For panels L. 159 cm	STRUTTURA BIFRONTALE DOUBLE-SIDED FRAME 	7M8625-GA	Grigio argento Silver grey Gris argenté Gris plata Silbergrau	Per pannelli For panels L. 159 cm	
	7M4625-BO	Bianco opaco Mat white Blanc mat Blanco mate Mattweiß	Per pannelli For panels L. 159 cm		7M8625-BO	Bianco opaco Mat white Blanc mat Blanco mate Mattweiß	Per pannelli For panels L. 159 cm	
	7M4225-GA	Grigio argento Silver grey Gris argenté Gris plata Silbergrau	Per pannelli For panels L. 119 cm		7M8225-GA	Grigio argento Silver grey Gris argenté Gris plata Silbergrau	Per pannelli For panels L. 119 cm	
	7M4225-BO	Bianco opaco Mat white Blanc mat Blanco mate Mattweiß	Per pannelli For panels L. 119 cm		7M8225-BO	Bianco opaco Mat white Blanc mat Blanco mate Mattweiß	Per pannelli For panels L. 119 cm	
	7M4825-GA	Grigio argento Silver grey Gris argenté Gris plata Silbergrau	Per pannelli For panels L. 75 cm		7M8825-GA	Grigio argento Silver grey Gris argenté Gris plata Silbergrau	Per pannelli For panels L. 75 cm	
	7M4825-BO	Bianco opaco Mat white Blanc mat Blanco mate Mattweiß	Per pannelli For panels L. 75 cm		7M8825-BO	Bianco opaco Mat white Blanc mat Blanco mate Mattweiß	Per pannelli For panels L. 75 cm	
		L. 159/119/75 cm				L. 159/119/75 cm		
	A	7M1016-XXXX o/or 7M1016BO-XXXX	L. 159 cm			A	7M1016-XXXX o/or 7M1016BO-XXXX	L. 159 cm
	B	7M4625-GA o/or 7M4625-BO				B	7M8625-GA o/or 7M8625-BO	
	o/or		L. 119 cm			o/or		L. 119 cm
A	7M1012-XXXX o/or 7M1012BO-XXXX	A		7M1012-XXXX o/or 7M1012BO-XXXX				
B	7M4225-GA o/or 7M4225-BO	B	7M8225-GA o/or 7M8225-BO					
o/or		L. 75 cm	o/or		L. 75 cm			
A	7M1008-XXXX o/or 7M1008BO-XXXX		A	7M1008-XXXX o/or 7M1008BO-XXXX				
B	7M4825-GA o/or 7M4825-BO	B	7M8825-GA o/or 7M8825-BO					

Struttura in acciaio verniciato con polveri epossidiche con basi in acciaio verniciato con polveri epossidiche per fissaggio a terra (viti non incluse) per il montaggio di **4 o 8** pannelli Mitesco.

Structure in powder-coated steel with powder-coated steel bases for floor fixing (screws not included), to mount **4 or 8** Mitesco panels.

Structure en acier peint époxy avec bases en acier peint époxy pour fixation au sol (vis pas incluses) pour le montage de **4 ou 8** panneaux Mitesco.

Estructura de acero recubierto epoxi con bases de acero recubierto epoxi para fijación al suelo (tornillos no incluidos) para el montaje de **4 o 8** paneles Mitesco.

Standssäulen aus pulverbeschichtetem Stahl mit Fuß zur Bodenbefestigung (Schrauben nicht inkludiert) aus pulverbeschichtetem Stahl zur Aufstellung von **4 oder 8** Mitesco-Paneeelen.

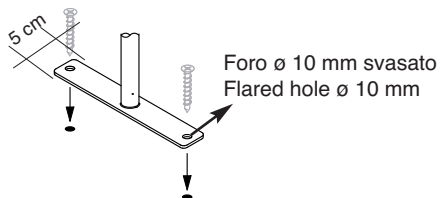

Foro ø 10 mm svasato
Flared hole ø 10 mm

Dettaglio della base (viti non incluse)
Detail of the base (screws not included)
Détail de la base (vis pas incluses)
Detalle de la base (tornillos no incluidos)
Details der Basis (Schrauben nicht inkludiert)

MITESCO DIVIDER

design Michele De Lucchi
Snowsound® technology by Caimi Brevetti

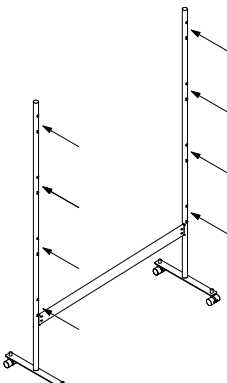
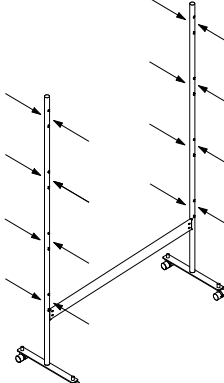
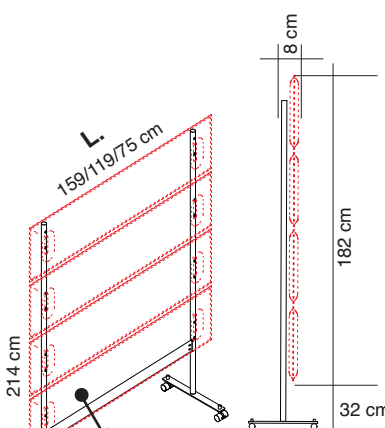
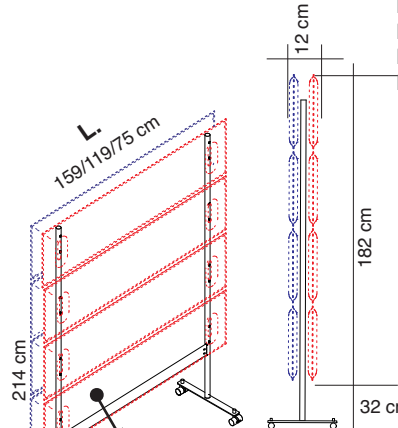
	Codice Code	Colore Colour	Prezzo Price		Codice Code	Colore Colour	Prezzo Price																	
STRUTTURA MONOFRONTALE ONE-SIDED FRAME 	7M4660-RGA	Grigio argento Silver grey Gris argenté Gris plata Silbergrau	Per pannelli For panels L. 159 cm	STRUTTURA BIFRONTALE DOUBLE-SIDED FRAME 	7M8660-RGA	Grigio argento Silver grey Gris argenté Gris plata Silbergrau	Per pannelli For panels L. 159 cm																	
	7M4660-RBO	Bianco opaco Mat white Blanc mat Blanco mate Mattweiß	Per pannelli For panels L. 159 cm		7M8660-RBO	Bianco opaco Mat white Blanc mat Blanco mate Mattweiß	Per pannelli For panels L. 159 cm																	
	7M4260-RGA	Grigio argento Silver grey Gris argenté Gris plata Silbergrau	Per pannelli For panels L. 119 cm		7M8260-RGA	Grigio argento Silver grey Gris argenté Gris plata Silbergrau	Per pannelli For panels L. 119 cm																	
	7M4260-RBO	Bianco opaco Mat white Blanc mat Blanco mate Mattweiß	Per pannelli For panels L. 119 cm		7M8260-RBO	Bianco opaco Mat white Blanc mat Blanco mate Mattweiß	Per pannelli For panels L. 119 cm																	
	7M4860-RGA	Grigio argento Silver grey Gris argenté Gris plata Silbergrau	Per pannelli For panels L. 75 cm		7M8860-RGA	Grigio argento Silver grey Gris argenté Gris plata Silbergrau	Per pannelli For panels L. 75 cm																	
	7M4860-RBO	Bianco opaco Mat white Blanc mat Blanco mate Mattweiß	Per pannelli For panels L. 75 cm		7M8860-RBO	Bianco opaco Mat white Blanc mat Blanco mate Mattweiß	Per pannelli For panels L. 75 cm																	
		<table border="1"> <tr> <td>A</td> <td>7M1016-XXXX o/or 7M1016BO-XXXX</td> <td rowspan="2">L. 159 cm</td> </tr> <tr> <td>B</td> <td>7M4660-RGA o/or 7M4660-RBO</td> </tr> </table>	A		7M1016-XXXX o/or 7M1016BO-XXXX	L. 159 cm	B	7M4660-RGA o/or 7M4660-RBO	<table border="1"> <tr> <td colspan="2" style="text-align: center;">o/or</td> </tr> <tr> <td>A</td> <td>7M1012-XXXX o/or 7M1012BO-XXXX</td> <td rowspan="2">L. 119 cm</td> </tr> <tr> <td>B</td> <td>7M4260-RGA o/or 7M4260-RBO</td> </tr> </table>	o/or		A	7M1012-XXXX o/or 7M1012BO-XXXX	L. 119 cm	B	7M4260-RGA o/or 7M4260-RBO	<table border="1"> <tr> <td colspan="2" style="text-align: center;">o/or</td> </tr> <tr> <td>A</td> <td>7M1008-XXXX o/or 7M1008BO-XXXX</td> <td rowspan="2">L. 75 cm</td> </tr> <tr> <td>B</td> <td>7M4860-RGA o/or 7M4860-RBO</td> </tr> </table>	o/or		A	7M1008-XXXX o/or 7M1008BO-XXXX	L. 75 cm	B	7M4860-RGA o/or 7M4860-RBO
	A	7M1016-XXXX o/or 7M1016BO-XXXX	L. 159 cm																					
	B	7M4660-RGA o/or 7M4660-RBO																						
	o/or																							
A	7M1012-XXXX o/or 7M1012BO-XXXX	L. 119 cm																						
B	7M4260-RGA o/or 7M4260-RBO																							
o/or																								
A	7M1008-XXXX o/or 7M1008BO-XXXX	L. 75 cm																						
B	7M4860-RGA o/or 7M4860-RBO																							
	<table border="1"> <tr> <td>A</td> <td>7M1016-XXXX o/or 7M1016BO-XXXX</td> <td rowspan="2">L. 159 cm</td> </tr> <tr> <td>B</td> <td>7M8660R-GA o/or 7M8660-RBO</td> </tr> </table>	A	7M1016-XXXX o/or 7M1016BO-XXXX	L. 159 cm	B	7M8660R-GA o/or 7M8660-RBO	<table border="1"> <tr> <td colspan="2" style="text-align: center;">o/or</td> </tr> <tr> <td>A</td> <td>7M1012-XXXX o/or 7M1012BO-XXXX</td> <td rowspan="2">L. 119 cm</td> </tr> <tr> <td>B</td> <td>7M8260-RGA o/or 7M8260-RBO</td> </tr> </table>	o/or		A	7M1012-XXXX o/or 7M1012BO-XXXX	L. 119 cm	B	7M8260-RGA o/or 7M8260-RBO	<table border="1"> <tr> <td colspan="2" style="text-align: center;">o/or</td> </tr> <tr> <td>A</td> <td>7M1008-XXXX o/or 7M1008BO-XXXX</td> <td rowspan="2">L. 75 cm</td> </tr> <tr> <td>B</td> <td>7M8860-RGA o/or 7M8860-RBO</td> </tr> </table>	o/or		A	7M1008-XXXX o/or 7M1008BO-XXXX	L. 75 cm	B	7M8860-RGA o/or 7M8860-RBO		
A	7M1016-XXXX o/or 7M1016BO-XXXX	L. 159 cm																						
B	7M8660R-GA o/or 7M8660-RBO																							
o/or																								
A	7M1012-XXXX o/or 7M1012BO-XXXX	L. 119 cm																						
B	7M8260-RGA o/or 7M8260-RBO																							
o/or																								
A	7M1008-XXXX o/or 7M1008BO-XXXX	L. 75 cm																						
B	7M8860-RGA o/or 7M8860-RBO																							

Struttura in acciaio verniciato con polveri epossidiche con basi in acciaio verniciato con polveri epossidiche con ruote in tecnopolimero (2 con freno e 2 senza) per il montaggio di 4 o 8 pannelli Mitesco.

Structure in powder-coated steel with powder-coated steel bases with high-tech polymer castors (2 with and 2 without brakes), to mount 4 or 8 Mitesco panels.

Structure en acier peint époxy avec bases en acier peint époxy et roulettes en technopolymère (2 avec freins et 2 sans) pour le montage de 4 ou 8 panneaux Mitesco.

Estructura de acero recubierto epoxi con bases de acero recubierto epoxi con ruedas en polimero (2 con freno y 2 sin) para el montaje de 4 o 8 paneles Mitesco.

Standssäulen aus pulverbeschichtetem Stahl mit Standfuß aus pulverbeschichtetem Stahl mit Rollen aus Technopolymer (2 davon feststellbar) zur Aufstellung von 4 oder 8 Mitesco-Paneeelen.

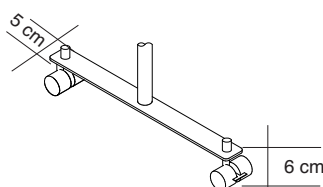

Dettaglio della base
Detail of the base
Détail de la base
Detaille de la base
Details der Basis

MITESCO CEILING

design Michele De Lucchi
Snowsound® technology by Caimi Brevetti



ø 4 cm

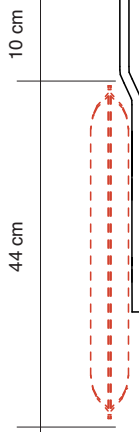
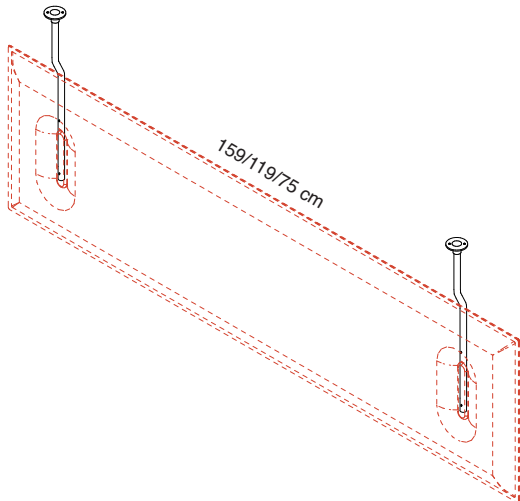
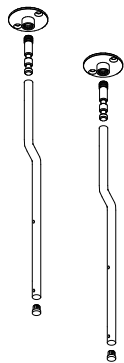

Codice
Code

7MBF50

Colore
Colour

Cromato
Chrome-plated
Chromé
Cromado
Verchromt

Prezzo
Price

1 coppia / 1 pair
1 paire / 1 pare
1 Paar

Descrizione
Description

Kit per fissaggio a soffitto di 1 pannello Mitesco in posizione verticale (baffle) composto da: 2 piastre a soffitto a 2 fori, 2 supporti (tubi) sagomati in acciaio cromato. Per questo tipo di appendimento a soffitto del pannello il profilo livellatore non è necessario

Kit for the ceiling fixing of 1 Mitesco panel in vertical position (baffle) composed of: 2 ceiling plates with 2 holes, 2 shaped supports (tubes) in chrome-plated steel. For this kind of ceiling hanging of the panel the leveler profile is not necessary.

Kit d'accrochage au plafond d'un panneau Mitesco en position verticale (baffle) composé de: 2 plaques à plafond à 2 trous, 2 supports (tubes) façonnés en acier chromé. Pour ce type d'accrochage du panneau au plafond, il ne faut aucun profil niveleur.

Kit para el montaje al techo de 1 panel Mitesco en posición vertical (baffle) compuesto por 2 placas de techo con 2 huecos, 2 soportes (tubos) conformados de acero cromado. Para ese tipo de montaje al techo del panel no es necesario el perfil nivelador.

Set zur Deckenbefestigung in vertikaler Position (Baffle) für 1 Mitesco-Panel, bestehend aus: 2 Deckenmontageplatten mit 2 Befestigungsbohrungen, 2 gebogene Halterungen (Rohre) aus verchromtem Stahl. Für diese Art der Deckenbefestigung ist das Justierprofil nicht notwendig.

MITESCO CEILING

design Michele De Lucchi
Snowsound® technology by Caimi Brevetti

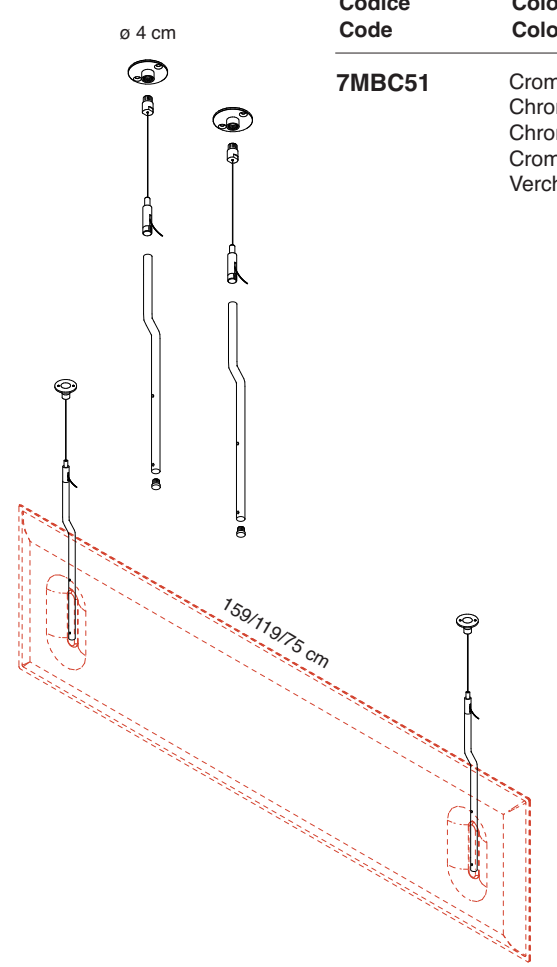
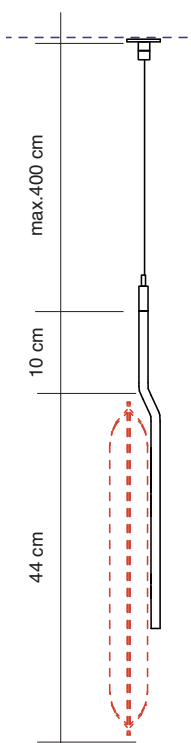
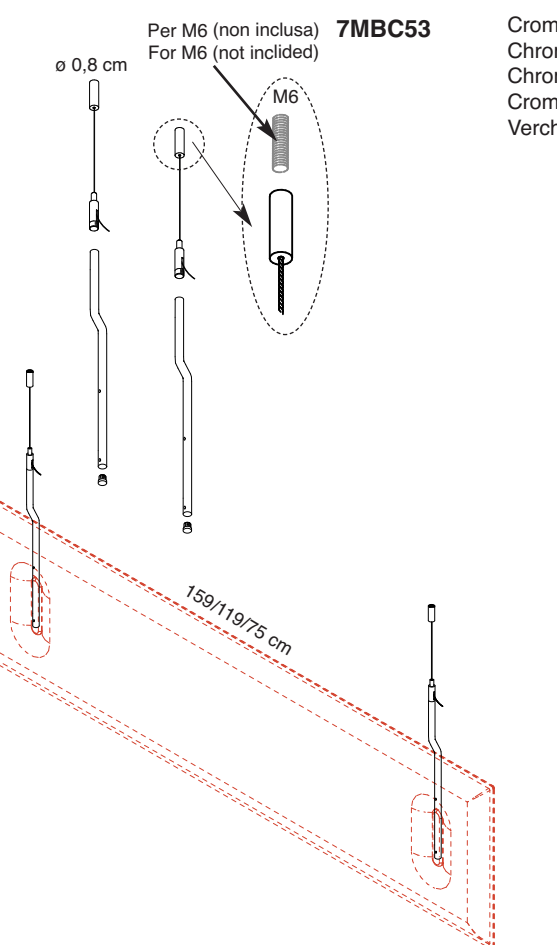
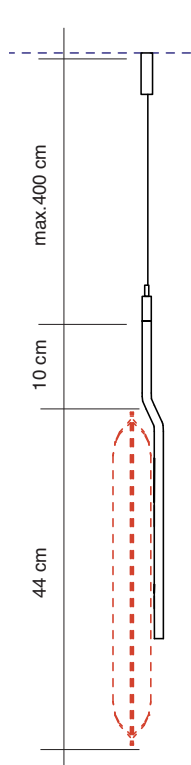
	Codice Code	Colore Colour	Prezzo Price	Descrizione Description
 <p>ø 4 cm</p> <p>159/119/75 cm</p>	<p>7MBC51</p>	<p>Cromato Chrome-plated Chromé Cromado Verchromt</p>	<p>1 coppia / 1 pair 1 paire / 1 pare 1 Paar</p>	<p>Kit per fissaggio a soffitto di 1 pannello Mitesco in posizione verticale (baffle) composto da: 2 piastre a soffitto a 2 fori, 2 cavi, 2 supporti (tubi) sagomati in acciaio cromato. Per questo tipo di appendimento a soffitto del pannello il profilo livellatore non è necessario</p> <p>Kit for the ceiling fixing of 1 Mitesco panel in vertical position (baffle) composed of: 2 ceiling plates with 2 holes, 2 cables, 2 shaped supports (tubes) in chrome-plated steel. For this kind of ceiling hanging of the panel the leveler profile is not necessary.</p> <p>Kit d'accrochage au plafond d'un panneau Mitesco en position verticale (baffle) composé de: 2 plaques à plafond à 2 trous, 2 cables, 2 supports (tubes) façonnés en acier chromé. Pour ce type d'accrochage du panneau au plafond, il ne faut aucun profil niveleur.</p> <p>Kit para el montaje al techo de 1 panel Mitesco en posición vertical (baffle) compuesto por 2 placas de techo con 2 huecos, 2 cables, 2 soportes (tubos) conformados de acero cromado. Para ese tipo de montaje al techo del panel no es necesario el perfil nivelador.</p> <p>Set zur Deckenbefestigung in vertikaler Position (Baffel) für 1 Mitesco-Paneel, bestehend aus: 2 Deckenmontageplatten mit 2 Befestigungsbohrungen, 2 Stahlseile, 2 gebogene Halterungen (Rohre) aus verchromtem Stahl. Für diese Art der Deckenbefestigung ist das Justierprofil nicht notwendig.</p>  <p>max. 400 cm</p> <p>10 cm</p> <p>44 cm</p>
 <p>ø 0,8 cm</p> <p>Per M6 (non inclusa) For M6 (not included)</p> <p>M6</p> <p>159/119/75 cm</p>	<p>7MBC53</p>	<p>Cromato Chrome-plated Chromé Cromado Verchromt</p>	<p>1 coppia / 1 pair 1 paire / 1 pare 1 Paar</p>	<p>Kit per fissaggio a soffitto di 1 pannello Mitesco in posizione verticale (baffle) composto da: 2 attacchi a soffitto filettati M6, 2 cavi, 2 supporti (tubi) sagomati in acciaio cromato. Per questo tipo di appendimento a soffitto del pannello il profilo livellatore non è necessario</p> <p>Kit for the ceiling fixing of 1 Mitesco panel in vertical position (baffle) composed of: 2 ceiling hanging threaded M6, 2 cables, 2 shaped supports (tubes) in chrome-plated steel. For this kind of ceiling hanging of the panel the leveler profile is not necessary.</p> <p>Kit d'accrochage au plafond d'un panneau Mitesco en position verticale (baffle) composé de: 2 accrochages au plafond filetés M6, 2 cables, 2 supports (tubes) façonnés en acier chromé. Pour ce type d'accrochage du panneau au plafond, il ne faut aucun profil niveleur.</p> <p>Kit para el montaje al techo de 1 panel Mitesco en posición vertical (baffle) compuesto por 2 fijaciones al techo roscadas M6, 2 cables, 2 soportes (tubos) conformados de acero cromado. Para ese tipo de montaje al techo del panel no es necesario el perfil nivelador.</p> <p>Set zur Deckenbefestigung in vertikaler Position (Baffel) für 1 Mitesco-Paneel, bestehend aus: 2 Deckenbefestigungen für Gewinde M6, 2 Stahlseile, 2 gebogene Halterungen (Rohre) aus verchromtem Stahl. Für diese Art der Deckenbefestigung ist das Justierprofil nicht notwendig.</p>  <p>max. 400 cm</p> <p>10 cm</p> <p>44 cm</p>

MITESCO CEILING

design Michele De Lucchi
Snowsound® technology by Caimi Brevetti

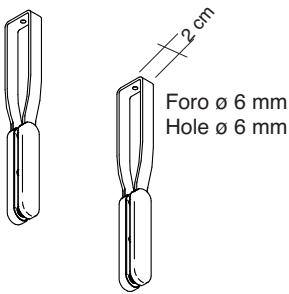
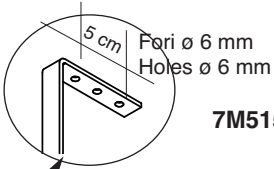
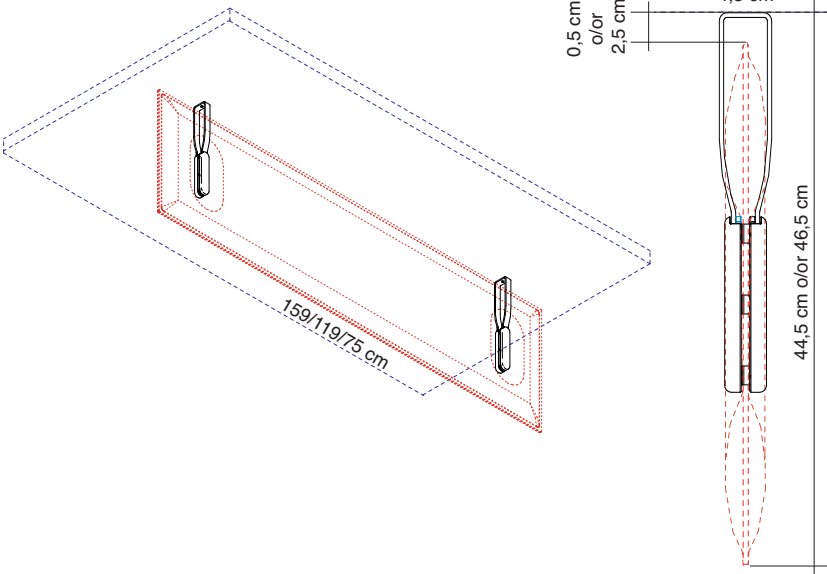
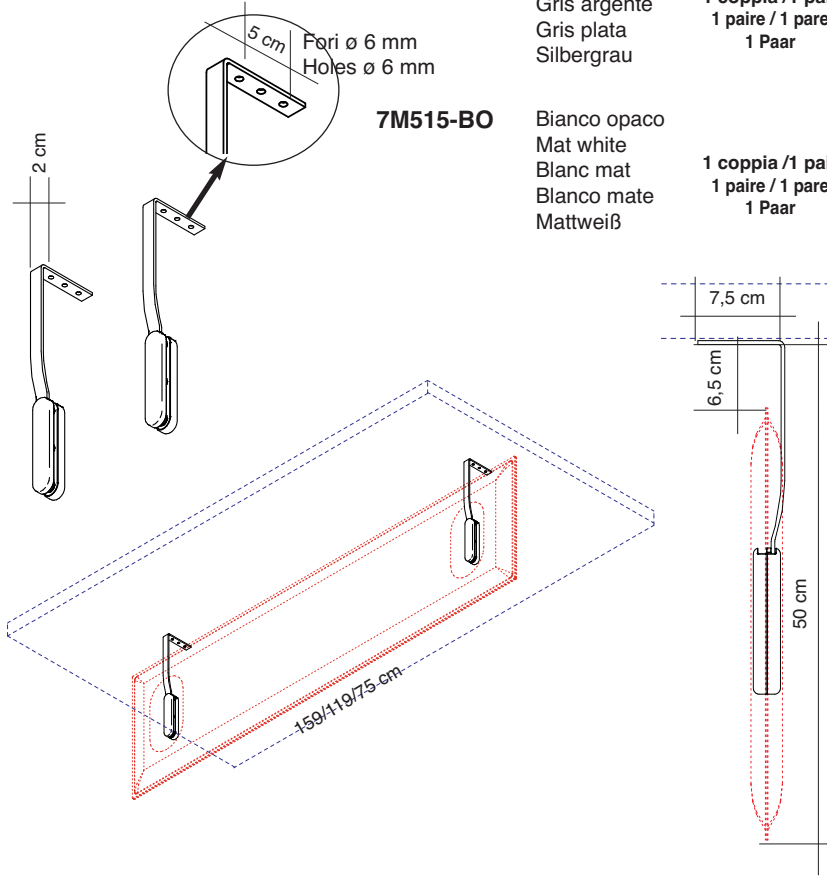
	Codice Code	Colore Colour	Prezzo Price	Descrizione Description
	7M511-GA	Grigio argento Silver grey Gris argenté Gris plata Silbergrau	1 coppia / 1 pair 1 paire / 1 pare 1 Paar	Coppia staffe in acciaio verniciato con polveri epossidiche per fissaggio a soffitto tramite viti (non incluse). Attacchi al pannello e coperture in tecnopolimero grigio o bianco. Per pannelli Mitesco Desk pag. 56.
	7M511-BO	Bianco opaco Mat white Blanc mat Blanco mate Mattweiß	1 coppia / 1 pair 1 paire / 1 pare 1 Paar	Pair of brackets in powder-coated steel to be fixed to the ceiling with screws (not included). Panel connections and front covers in grey or white high-tech polymer. For Mitesco Desk panels page 56.
	7M515-GA	Grigio argento Silver grey Gris argenté Gris plata Silbergrau	1 coppia / 1 pair 1 paire / 1 pare 1 Paar	Coppia staffe in acciaio verniciato con polveri epossidiche per fissaggio a soffitto tramite viti (non incluse). Attacchi al pannello e coperture in tecnopolimero grigio o bianco. Per pannelli Mitesco Desk pag. 56.
	7M515-BO	Bianco opaco Mat white Blanc mat Blanco mate Mattweiß	1 coppia / 1 pair 1 paire / 1 pare 1 Paar	Pair of brackets in powder-coated steel to be fixed to the ceiling with screws (not included). Panel connections and front covers in grey or white high-tech polymer. For Mitesco Desk panels page 56.
				<p>Paire d'étriers en acier peint en époxy pour fixation au plafond par des vis (pas incluses). Jonctions au panneau et couvertures en technopolymère gris ou blanc. Pour Mitesco Desk panneaux page 56.</p> <p>Par de abrazaderas de acero recubierto epoxi para fijación al techo con tornillos (no incluidos). Enganches al panel y coberturas de polímero gris o blanco. Para Mitesco Desk panels page 56.</p> <p>1 Paar Halterungen aus pulverbeschichtetem Stahl zur Deckenbefestigung mittels Schrauben (nicht inkludiert). Paneelbefestigungen und Abdeckungen aus grauem oder weißem Technopolymer. Für Mitesco Desk Paneele, Seite 56.</p>
				<p>Paire d'étriers en acier peint en époxy pour fixation au plafond par des vis (pas incluses). Jonctions au panneau et couvertures en technopolymère gris ou blanc. Pour Mitesco Desk panneaux page 56.</p> <p>Par de abrazaderas de acero recubierto epoxi para fijación al techo con tornillos (no incluidos). Enganches al panel y coberturas de polímero gris o blanco. Para Mitesco Desk panels page 56.</p> <p>1 Paar Halterungen aus pulverbeschichtetem Stahl zur Deckenbefestigung mittels Schrauben (nicht inkludiert). Paneelbefestigungen und Abdeckungen aus grauem oder weißem Technopolymer. Für Mitesco Desk Paneele, Seite 56.</p>
				<p>Paire d'étriers en acier peint en époxy pour fixation au plafond par des vis (pas incluses). Jonctions au panneau et couvertures en technopolymère gris ou blanc. Pour Mitesco Desk panneaux page 56.</p> <p>Par de abrazaderas de acero recubierto epoxi para fijación al techo con tornillos (no incluidos). Enganches al panel y coberturas de polímero gris o blanco. Para Mitesco Desk panels page 56.</p> <p>1 Paar Halterungen aus pulverbeschichtetem Stahl zur Deckenbefestigung mittels Schrauben (nicht inkludiert). Paneelbefestigungen und Abdeckungen aus grauem oder weißem Technopolymer. Für Mitesco Desk Paneele, Seite 56.</p>
				<p>Paire d'étriers en acier peint en époxy pour fixation au plafond par des vis (pas incluses). Jonctions au panneau et couvertures en technopolymère gris ou blanc. Pour Mitesco Desk panneaux page 56.</p> <p>Par de abrazaderas de acero recubierto epoxi para fijación al techo con tornillos (no incluidos). Enganches al panel y coberturas de polímero gris o blanco. Para Mitesco Desk panels page 56.</p> <p>1 Paar Halterungen aus pulverbeschichtetem Stahl zur Deckenbefestigung mittels Schrauben (nicht inkludiert). Paneelbefestigungen und Abdeckungen aus grauem oder weißem Technopolymer. Für Mitesco Desk Paneele, Seite 56.</p>

MITESCO CEILING

design Michele De Lucchi
Snowsound® technology by Caimi Brevetti

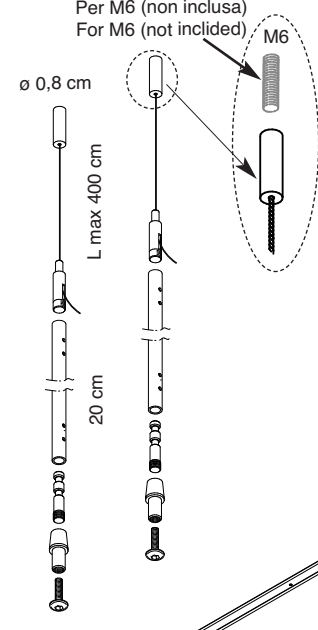
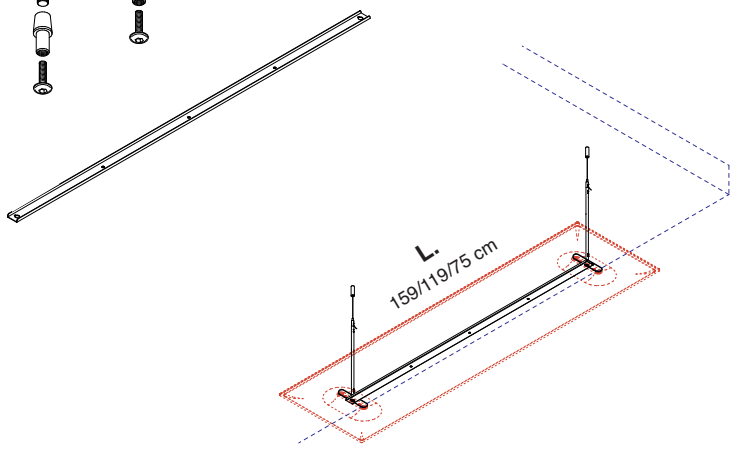
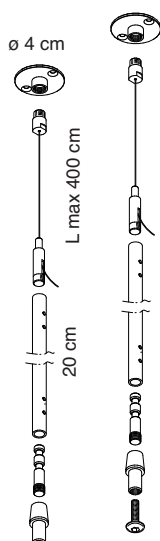
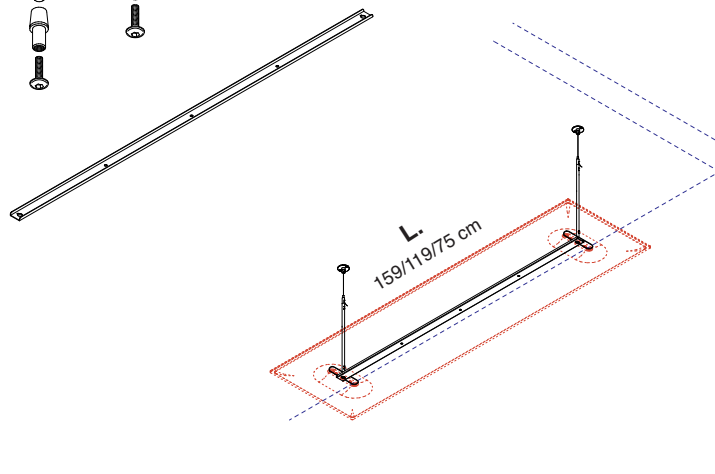
	Codice Code	Colore Colour	Prezzo Price	Descrizione Description
<p>Per M6 (non inclusa) For M6 (not included)</p>  	<p>7MCC2116</p>	<p>Cromato Chrome-plated Chromé Cromado Verchromt</p>	<p>Per pannelli For panels L. 159 cm</p>	<p>Kit per fissaggio a soffitto di un pannello Mitesco in posizione orizzontale composto da: 2 attacchi a soffitto filettati M6, 2 cavi, 2 supporti (tubi) in acciaio cromato, 2 attacchi per pannello, 1 profilo livellatore.</p>
	<p>7MCC2112</p>	<p>Cromato Chrome-plated Chromé Cromado Verchromt</p>	<p>Per pannelli For panels L. 119 cm</p>	<p>Kit for the ceiling fixing of a Mitesco panel in horizontal position composed of: 2 ceiling hanging threaded M6, 2 supports (tubes) in chrome-plated steel, 2 cables, 2 hangings for the panel, 1 leveler profile.</p>
	<p>7MCC2108</p>	<p>Cromato Chrome-plated Chromé Cromado Verchromt</p>	<p>Per pannelli For panels L. 75 cm</p>	<p>Kit d'accrochage au plafond d'un panneau Mitesco en position horizontale composé de: 2 accrochages au plafond filetés M6, 2 supports (tubes) en acier chromé, 2 câbles, 2 accrochages pour panneau, 1 profil niveleur.</p> <p>Kit para el montaje al techo de 1 panel Mitesco en posición horizontal compuesto por: 2 fijaciones al techo roscadas M6, 2 soportes (tubos) de acero cromado, 2 cables, 2 enganches para el panel, 1 perfil nivelador.</p> <p>Set für die Deckenbefestigung eines Mitesco-Panels in horizontaler Position, bestehend aus: 2 Deckenbefestigungen für Gewinde M6, 2 Halterungen (Rohre) aus verchromtem Stahl, 2 Stahlseile, 2 Paneelbefestigungen, 1 Justierprofil.</p>
 	<p>7MCC2216</p>	<p>Cromato Chrome-plated Chromé Cromado Verchromt</p>	<p>Per pannelli For panels L. 159 cm</p>	<p>Kit per fissaggio a soffitto di un pannello Mitesco in posizione orizzontale composto da: 2 piastre a soffitto a 2 fori, 2 supporti (tubi) in acciaio cromato, 2 cavi, 2 attacchi per pannello, 1 profilo livellatore.</p>
	<p>7MCC2212</p>	<p>Cromato Chrome-plated Chromé Cromado Verchromt</p>	<p>Per pannelli For panels L. 119 cm</p>	<p>Kit for the ceiling fixing of a Mitesco panel in horizontal position composed of: 2 ceiling plates with 2 holes, 2 supports (tubes) in chrome-plated steel, 2 cables, 2 hangings for the panel, 1 leveler profile.</p>
	<p>7MCC2208</p>	<p>Cromato Chrome-plated Chromé Cromado Verchromt</p>	<p>Per pannelli For panels L. 75 cm</p>	<p>Kit d'accrochage au plafond d'un panneau Mitesco en position horizontale composé de: 2 plaques pour plafond à 2 trous, 2 supports (tubes) en acier chromé, 2 câbles, 2 accrochages pour panneau, 1 profil niveleur.</p> <p>Kit para el montaje al techo de 1 panel Mitesco en posición horizontal compuesto por: 2 placas de techo con 2 huecos, 2 soportes (tubos) de acero cromado, 2 cables, 2 enganches para el panel, 1 perfil nivelador.</p> <p>Set für die Deckenbefestigung eines Mitesco-Panels in horizontaler Position, bestehend aus: 2 Deckenmontageplatten mit 2 Befestigungsbohrungen, 2 Halterungen (Rohre) aus verchromtem Stahl, 2 Stahlseile, 2 Paneelbefestigungen, 1 Justierprofil.</p>

MITESCO CEILING

design Michele De Lucchi
Snowsound® technology by Caimi Brevetti

	Codice Code	Colore Colour	Prezzo Price	Descrizione Description
	7MCF0116	Cromato Chrome-plated Chromé Cromado Verchromt	Per pannelli For panels L. 159 cm	Kit per fissaggio a soffitto di un pannello Mitesco in posizione orizzontale composto da: 2 piastre a soffitto a 2 fori, 2 supporti (tubi) in acciaio cromato, 2 attacchi per pannello, 1 profilo livellatore.
	7MCF0112	Cromato Chrome-plated Chromé Cromado Verchromt	Per pannelli For panels L. 119 cm	Kit for the ceiling fixing of a Mitesco panel in horizontal position composed of: 2 ceiling plates with 2 holes, 2 supports (tubes) in chrome-plated steel, 2 hangings for the panel, 1 leveler profile.
	7MCF0108	Cromato Chrome-plated Chromé Cromado Verchromt	Per pannelli For panels L. 75 cm	Kit d'accrochage au plafond d'un panneau Mitesco en position horizontale composé de: 2 plaques pour plafond à 2 trous, 2 supports (tubes) en acier chromé, 2 accrochages pour panneau, 1 profil niveleur.
	7MCF0216	Cromato Chrome-plated Chromé Cromado Verchromt	Per pannelli For panels L. 159 cm	Kit per fissaggio a soffitto di un pannello Mitesco in posizione orizzontale composto da: 2 piastre a soffitto a 2 fori, 2 supporti (tubi) in acciaio cromato, 2 attacchi per pannello, 1 profilo livellatore.
	7MCF0212	Cromato Chrome-plated Chromé Cromado Verchromt	Per pannelli For panels L. 119 cm	Kit for the ceiling fixing of a Mitesco panel in horizontal position composed of: 2 ceiling plates with 2 holes, 2 supports (tubes) in chrome-plated steel, 2 hangings for the panel, 1 leveler profile.
	7MCF0208	Cromato Chrome-plated Chromé Cromado Verchromt	Per pannelli For panels L. 75 cm	Kit d'accrochage au plafond d'un panneau Mitesco en position horizontale composé de: 2 plaques pour plafond à 2 trous, 2 supports (tubes) en acier chromé, 2 accrochages pour panneau, 1 profil niveleur.
				Kit para el montaje al techo de 1 panel Mitesco en posición horizontal compuesto por: 2 placas de techo con 2 huecos, 2 soportes (tubos) de acero cromado, 2 enganches para el panel, 1 perfil nivelador.
				Set für die Deckenbefestigung eines Mitesco-Panels in horizontaler Position, bestehend aus: 2 Deckenmontageplatten mit 2 Befestigungsbohrungen, 2 Halterungen (Rohre) aus verchromtem Stahl, 2 Paneelbefestigungen, 1 Justierungsprofil.

MITESCO CEILING

design Michele De Lucchi
Snowsound® technology by Caimi Brevetti

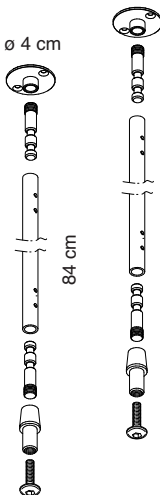
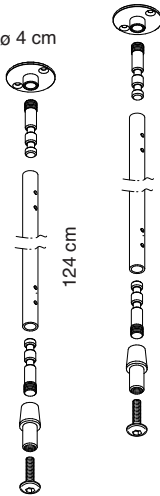
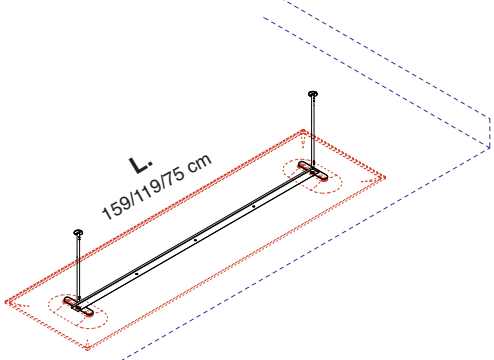
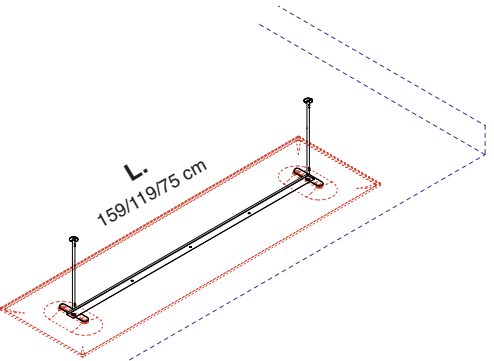
	Codice Code	Colore Colour	Prezzo Price	Descrizione Description
	7MCF0316	Cromato Chrome-plated Chromé Cromado Verchromt	Per pannelli For panels L. 159 cm	Kit per fissaggio a soffitto di un pannello Mitesco in posizione orizzontale composto da: 2 piastre a soffitto a 2 fori, 2 supporti (tubi) in acciaio cromato, 2 attacchi per pannello, 1 profilo livellatore.
	7MCF0312	Cromato Chrome-plated Chromé Cromado Verchromt	Per pannelli For panels L. 119 cm	Kit for the ceiling fixing of a Mitesco panel in horizontal position composed of: 2 ceiling plates with 2 holes, 2 supports (tubes) in chrome-plated steel, 2 hangings for the panel, 1 leveler profile.
	7MCF0308	Cromato Chrome-plated Chromé Cromado Verchromt	Per pannelli For panels L. 75 cm	Kit d'accrochage au plafond d'un panneau Mitesco en position horizontale composé de: 2 plaques pour plafond à 2 trous, 2 supports (tubes) en acier chromé, 2 accrochages pour panneau, 1 profil niveleur.
	7MCF0416	Cromato Chrome-plated Chromé Cromado Verchromt	Per pannelli For panels L. 159 cm	Kit per fissaggio a soffitto di un pannello Mitesco in posizione orizzontale composto da: 2 piastre a soffitto a 2 fori, 2 supporti (tubi) in acciaio cromato, 2 attacchi per pannello, 1 profilo livellatore.
	7MCF0412	Cromato Chrome-plated Chromé Cromado Verchromt	Per pannelli For panels L. 119 cm	Kit for the ceiling fixing of a Mitesco panel in horizontal position composed of: 2 ceiling plates with 2 holes, 2 supports (tubes) in chrome-plated steel, 2 hangings for the panel, 1 leveler profile.
	7MCF0408	Cromato Chrome-plated Chromé Cromado Verchromt	Per pannelli For panels L. 75 cm	Kit d'accrochage au plafond d'un panneau Mitesco en position horizontale composé de: 2 plaques pour plafond à 2 trous, 2 supports (tubes) en acier chromé, 2 accrochages pour panneau, 1 profil niveleur.
				
				

MITESCO CEILING

design Michele De Lucchi
Snowsound® technology by Caimi Brevetti

	Codice Code	Colore Colour	Prezzo Price	Descrizione Description
	7MCS1116	Cromato Chrome-plated Chromé Cromado Verchromt	Per pannelli For panels L. 159 cm	Kit per fissaggio a soffitto di un pannello Mitesco composto da: 2 piastre a soffitto a 2 fori, 2 supporti (tubi) in acciaio cromato, 2 attacchi per pannello con snodo per inclinazione del pannello, 1 profilo livellatore.
	7MCS1112	Cromato Chrome-plated Chromé Cromado Verchromt	Per pannelli For panels L. 119 cm	Kit for the ceiling fixing of a Mitesco panel composed of: 2 ceiling plates with 2 holes, 2 supports (tubes) in chrome-plated steel, 2 hangings with articulated joint for the inclination of the panel, 1 leveler profile.
	7MCS1108	Cromato Chrome-plated Chromé Cromado Verchromt	Per pannelli For panels L. 75 cm	Kit d'accrochage au plafond d'un panneau Mitesco composé de: 2 plaques pour plafond à 2 trous, 2 supports (tubes) en acier chromé, 2 accrochages pour panneau avec articulation pour l'inclinaison du panneau, 1 profil niveleur.
	7MCS1216	Cromato Chrome-plated Chromé Cromado Verchromt	Per pannelli For panels L. 159 cm	Kit per fissaggio a soffitto di un pannello Mitesco composto da: 2 piastre a soffitto a 2 fori, 2 supporti (tubi) in acciaio cromato, 2 attacchi per pannello con snodo per inclinazione del pannello, 1 profilo livellatore.
	7MCS1212	Cromato Chrome-plated Chromé Cromado Verchromt	Per pannelli For panels L. 119 cm	Kit for the ceiling fixing of a Mitesco panel composed of: 2 ceiling plates with 2 holes, 2 supports (tubes) in chrome-plated steel, 2 hangings with articulated joint for the inclination of the panel, 1 leveler profile.
	7MCS1208	Cromato Chrome-plated Chromé Cromado Verchromt	Per pannelli For panels L. 75 cm	Kit d'accrochage au plafond d'un panneau Mitesco composé de: 2 plaques pour plafond à 2 trous, 2 supports (tubes) en acier chromé, 2 accrochages pour panneau avec articulation pour l'inclinaison du panneau, 1 profil niveleur.
			L. 159/119/75 cm	Kit para el montaje al techo de 1 panel Mitesco compuesto por: 2 placas de techo con 2 huecos, 2 soportes (tubos) de acero cromado, 2 enganches con articulación para la inclinación del panel, 1 perfil nivelador.
				Set für die Deckenbefestigung eines Mitesco-Paneels, bestehend aus: 2 Deckenmontageplatten mit 2 Befestigungsbohrungen, 2 Halterungen (Rohre) aus verchromtem Stahl, 2 Paneelbefestigungen mit Gelenk zur Neigung des Paneels, 1 Justierungsprofil.

MITESCO CEILING

design Michele De Lucchi
Snowsound® technology by Caimi Brevetti

	Codice Code	Colore Colour	Prezzo Price	Descrizione Description
	7MCS1316	Cromato Chrome-plated Chromé Cromado Verchromt	Per pannelli For panels L. 159 cm	Kit per fissaggio a soffitto di un pannello Mitesco composto da: 2 piastre a soffitto a 2 fori, 2 supporti (tubi) in acciaio cromato, 2 attacchi per pannello con snodo per inclinazione del pannello, 1 profilo livellatore.
	7MCS1312	Cromato Chrome-plated Chromé Cromado Verchromt	Per pannelli For panels L. 119 cm	Kit for the ceiling fixing of a Mitesco panel composed of: 2 ceiling plates with 2 holes, 2 supports (tubes) in chrome-plated steel, 2 hangings with articulated joint for the inclination of the panel, 1 leveler profile.
	7MCS1308	Cromato Chrome-plated Chromé Cromado Verchromt	Per pannelli For panels L. 75 cm	Kit d'accrochage au plafond d'un panneau Mitesco composé de: 2 plaques pour plafond à 2 trous, 2 supports (tubes) en acier chromé, 2 accrochages pour panneau avec articulation pour l'inclinaison du panneau, 1 profil niveleur.
	7MCS1416	Cromato Chrome-plated Chromé Cromado Verchromt	Per pannelli For panels L. 159 cm	Kit per fissaggio a soffitto di un pannello Mitesco composto da: 2 piastre a soffitto a 2 fori, 2 supporti (tubi) in acciaio cromato, 2 attacchi per pannello con snodo per inclinazione del pannello, 1 profilo livellatore.
	7MCS1412	Cromato Chrome-plated Chromé Cromado Verchromt	Per pannelli For panels L. 119 cm	Kit for the ceiling fixing of a Mitesco panel composed of: 2 ceiling plates with 2 holes, 2 supports (tubes) in chrome-plated steel, 2 hangings with articulated joint for the inclination of the panel, 1 leveler profile.
	7MCS1408	Cromato Chrome-plated Chromé Cromado Verchromt	Per pannelli For panels L. 75 cm	Kit d'accrochage au plafond d'un panneau Mitesco composé de: 2 plaques pour plafond à 2 trous, 2 supports (tubes) en acier chromé, 2 accrochages pour panneau avec articulation pour l'inclinaison du panneau, 1 profil niveleur.
				Kit para el montaje al techo de 1 panel Mitesco compuesto por: 2 placas de techo con 2 huecos, 2 soportes (tubos) de acero cromado, 2 enganches con articulación para la inclinación del panel, 1 perfil nivelador.
				Set für die Deckenbefestigung eines Mitesco-Paneels, bestehend aus: 2 Deckenmontageplatten mit 2 Befestigungsbohrungen, 2 Halterungen (Rohre) aus verchromtem Stahl, 2 Paneelbefestigungen mit Gelenk zur Neigung des Paneels, 1 Justierprofil.

MITESCO FRAME

design Michele De Lucchi
Snowsound® technology by Caimi Brevetti

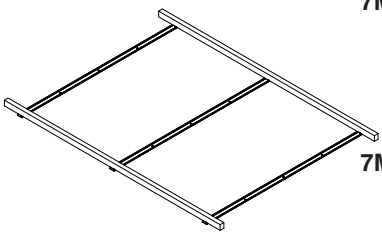
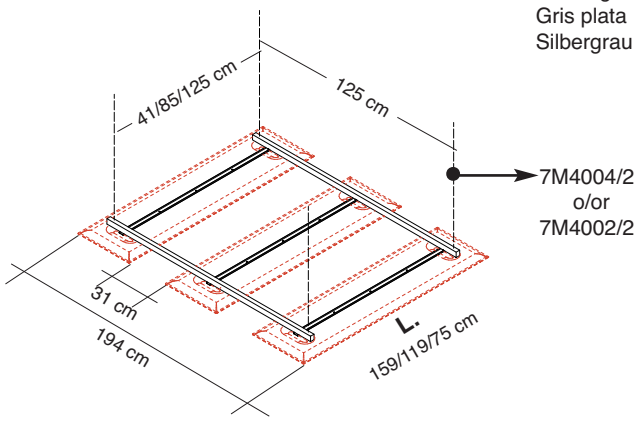
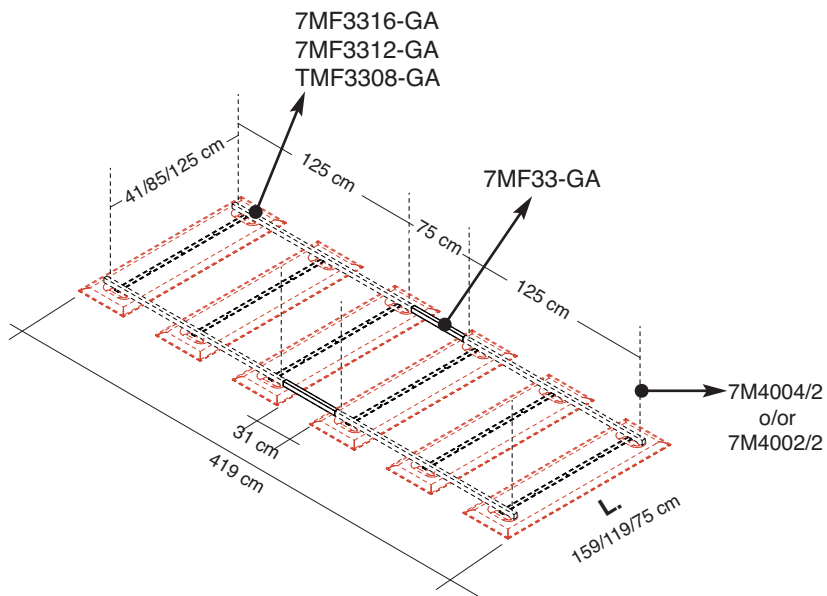
	Codice Code	Colore Colour	Prezzo Price	Descrizione Description
	7MF3316-GA	Grigio argento Silver grey Gris argenté Gris plata Silbergrau	Per pannelli For panels L. 159 cm	Telaio in acciaio verniciato con polveri epossidiche completo di 3 profili livellatori per appendimento a soffitto di 3 pannelli Mitesco
	7MF3312-GA	Grigio argento Silver grey Gris argenté Gris plata Silbergrau		Cadre en acier peint en époxy avec 3 profils niveleurs pour accrochage au plafond de 3 panneaux Mitesco.
	7MF3308-GA	Grigio argento Silver grey Gris argenté Gris plata Silbergrau		Bastidor de acero recubierto epoxi completos de 3 perfiles niveladores para fijación al techo de 3 paneles Mitesco
				Rahmen aus pulverbeschichtetem Stahl für die Deckenaufhängung von 3 Mitesco-Paneelen, inklusive 3 Justierungsprofilen.
	7MF33-GA	Grigio argento Silver grey Gris argenté Gris plata Silbergrau	1 coppia / 1 pair 1 paire / 1 pare 1 Paar	Coppia giunti distanziali in acciaio verniciato con polveri epossidiche per telai da 3 pannelli cod. 7MF3316-GA / 7MF3312-GA / 7MF3308-GA Pair of spacer joints in powder coated steel for 3 panels frame code 7MF3316-GA / 7MF3312-GA / 7MF3308-GA. Paire de joints espaceurs en acier peint en époxy pour cadres à 3 panneaux, réf. 7MF3316-GA / 7MF3312-GA / 7MF3308-GA. Par de juntas espaciadoras de acero recubierto epoxi para bastidores de 3 paneles cod.7MF3316-GA / 7MF3312-GA / 7MF3308-GA. 1 Paar Abstandhalter aus pulverbeschichtetem Stahl für Rahmen zur Abhängung von 3 Paneelen, Art. Nr. 7MF3316-GA / 7MF3312-GA / 7MF3308-GA.
				

MITESCO FRAME

design Michele De Lucchi
Snowsound® technology by Caimi Brevetti

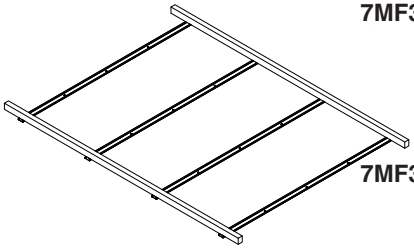
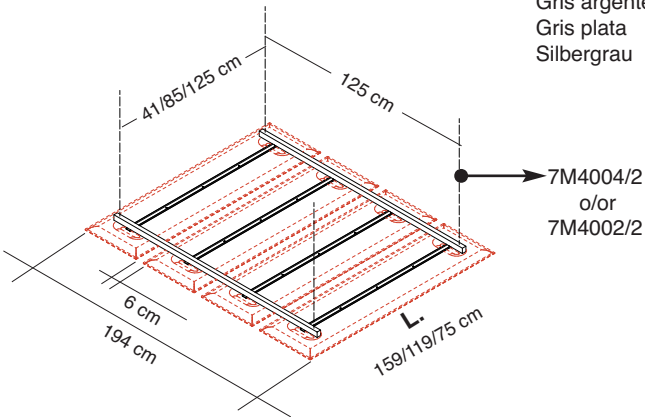
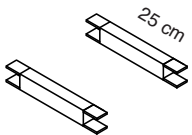
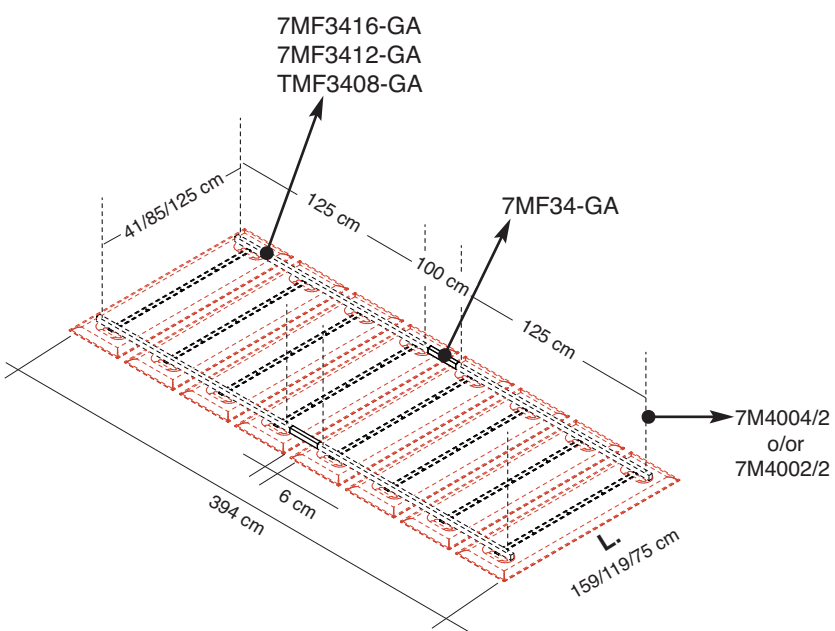
	Codice Code	Colore Colour	Prezzo Price	Descrizione Description
	7MF3416-GA	Grigio argento Silver grey Gris argenté Gris plata Silbergrau	Per pannelli For panels L. 159 cm	Telaio in acciaio verniciato con polveri epossidiche completo di 4 profili livellatori per appendimento a soffitto di 4 pannelli Mitesco Frame in powder coated steel with 4 leveler profiles for ceiling hanging of 4 Mitesco panels.
	7MF3412-GA	Grigio argento Silver grey Gris argenté Gris plata Silbergrau	Per pannelli For panels L. 119 cm	Cadre en acier peint en époxy avec 4 profils niveleurs pour accrochage au plafond de 4 panneaux Mitesco. Bastidor de acero recubierto epoxi completos de 4 perfiles niveladores para fijación al techo de 4 paneles Mitesco
	7MF3408-GA	Grigio argento Silver grey Gris argenté Gris plata Silbergrau	Per pannelli For panels L. 75 cm	Rahmen aus pulverbeschichtetem Stahl für die Deckenaufhängung von 4 Mitesco-Paneelen, inklusive 4 Justierungsprofilen.
				
	7MF34-GA	Grigio argento Silver grey Gris argenté Gris plata Silbergrau	1 coppia / 1 pair 1 paire / 1 pare 1 Paar	Coppia giunti distanziali in acciaio verniciato con polveri epossidiche per telai da 4 pannelli cod. 7MF3416-GA / 7MF3412-GA / 7MF3408-GA Pair of spacer joints in power coated steel for 4 panels frame code 7MF3416-GA / 7MF3412-GA / 7MF3408-GA. Paire de joints espaceurs en acier peint en époxy pour cadres à 4 panneau, réf. 7MF3416-GA / 7MF3412-GA / 7MF3408-GA. Par de juntas espaciadoras de acero recubierto epoxi para bastidores de 4 paneles cod.7MF3416-GA / 7MF3412-GA / 7MF3408-GA. 1 Paar Abstandhalter aus pulverbeschichtetem Stahl für Rahmen zur Abhängung von 4 Paneelen, Art. Nr. 7MF3416-GA / 7MF3412-GA / 7MF3408-GA.
				

MITESCO FRAME

design Michele De Lucchi
Snowsound® technology by Caimi Brevetti

	Codice Code	Colore Colour	Prezzo Price	Descrizione Description
<p>ø 0,8 cm</p> <p>L max 400 cm</p> <p>Per M6 (non inclusa) For M6 (not included)</p>	7M4004/2	Cromato Chrome-plated Chromé Cromado Verchromt		<p>Kit per fissaggio a soffitto del telaio 7MF3316-GA / 7MF3312-GA / 7MF3308-GA e 7MF3416-GA / 7MF3412-GA / 7MF3408-GA composto da: 4 attacchi a soffitto filettati M6 - 4 cavi in acciaio - 4 attacchi per telaio.</p> <p>Kit for the ceiling fixing of frame 7MF3316-GA / 7MF3312-GA / 7MF3308-GA and 7MF3416-GA / 7MF3412-GA / 7MF3408-GA composed of: 4 ceiling hanging threaded M6, 4 steel cables, 4 hangings for frame.</p> <p>Kit d'accrochage au plafond du cadre 7MF3316-GA / 7MF3312-GA / 7MF3308-GA et 7MF3416-GA / 7MF3412-GA / 7MF3408-GA composé de: 4 accrochages au plafond filetés M6 – 4 câbles en acier – 4 accrochages pour cadre</p> <p>Kit para el montaje al techo del bastidor 7MF3316-GA / 7MF3312-GA / 7MF3308-GA y 7MF3416-GA / 7MF3412-GA / 7MF3408-GA compuesto por: 4 enganches al techo roscados M6 – 4 cables de acero - 4 enganches para bastidor.</p> <p>Set für die Deckenbefestigung des Rahmens 7MF3316-GA / 7MF3312-GA / 7MF3308-GA und 7MF3416-GA / 7MF3412-GA / 7MF3408-GA bestehend aus: 4 Deckenbefestigungen für Gewinde M6, 4 Stahlseile, 4 Befestigungen für den Rahmen.</p>
<p>ø 4 cm</p> <p>L max 400 cm</p>	7M4002/2	Cromato Chrome-plated Chromé Cromado Verchromt		<p>Kit per fissaggio a soffitto del telaio 7MF3316-GA / 7MF3312-GA / 7MF3308-GA e 7MF3416-GA / 7MF3412-GA / 7MF3408-GA composto da: 4 piastre a soffitto a 2 fori - 4 cavi in acciaio - 4 attacchi per telaio.</p> <p>Kit for the ceiling fixing of frame 7MF3316-GA / 7MF3312-GA / 7MF3308-GA and 7MF3416-GA / 7MF3412-GA / 7MF3408-GA composed of: 4 ceiling plates with 2 holes, 4 steel cables, 4 hangings for frame.</p> <p>Kit d'accrochage au plafond du cadre 7MF3316-GA / 7MF3312-GA / 7MF3308-GA et 7MF3416-GA / 7MF3412-GA / 7MF3408-GA composé de: 4 plaques pour plafond à 2 trous – 4 câbles en acier – 4 accrochages pour cadre</p> <p>Kit para el montaje al techo del bastidor 7MF3316-GA / 7MF3312-GA / 7MF3308-GA y 7MF3416-GA / 7MF3412-GA / 7MF3408-GA compuesto por: 4 placas de techo con 2 huecos – 4 cables de acero - 4 enganches para bastidor.</p> <p>Set für die Deckenbefestigung des Rahmens 7MF3316-GA / 7MF3312-GA / 7MF3308-GA und 7MF3416-GA / 7MF3412-GA / 7MF3408-GA bestehend aus: 4 Deckenmontageplatten mit 2 Befestigungsbohrungen, 4 Stahlseile, 4 Befestigungen für den Rahmen.</p>

MITESCO FRAME

design Michele De Lucchi
Snowsound® technology by Caimi Brevetti



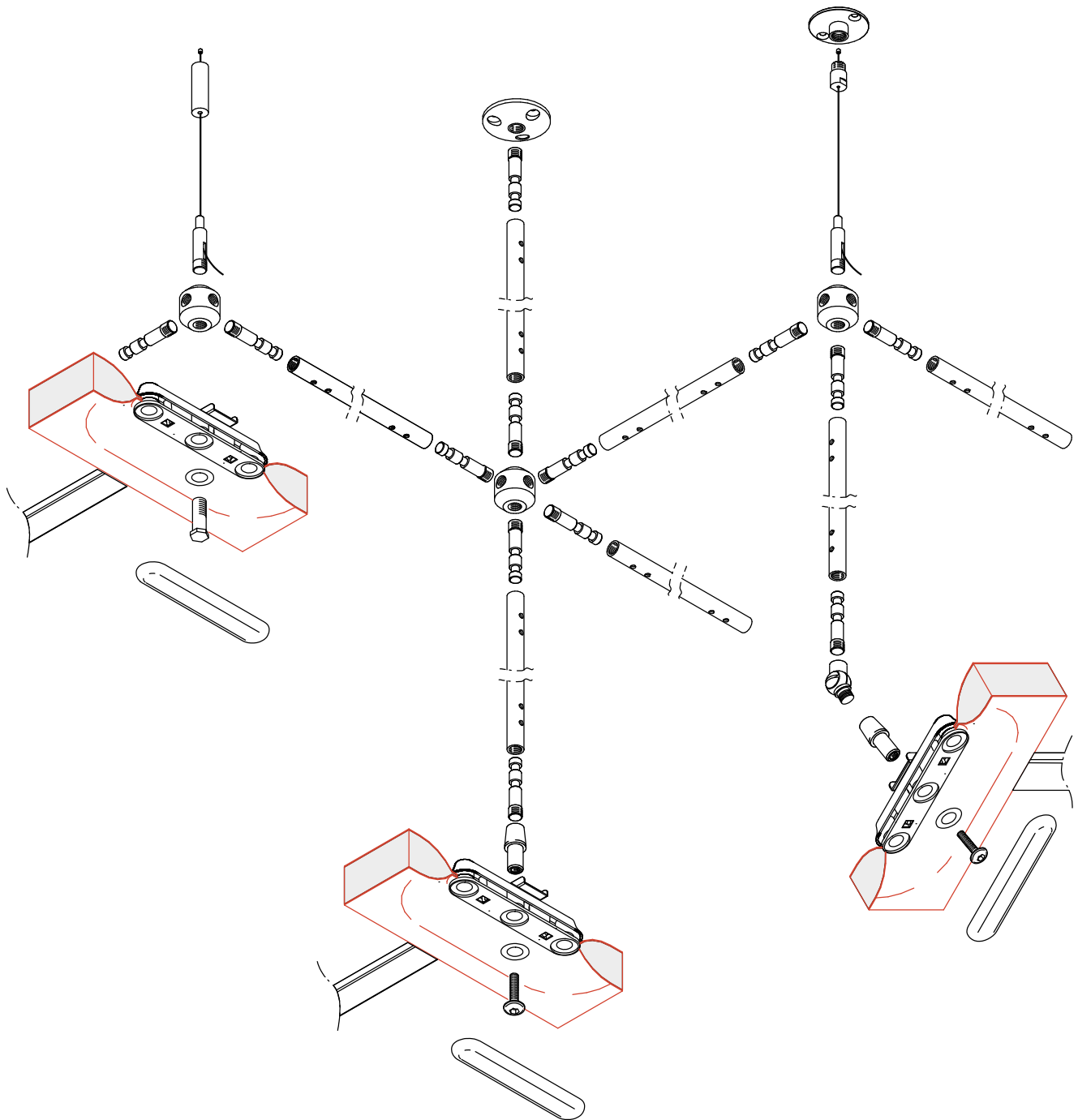

**Esempio di struttura reticolare per l'appendimento a soffitto dei pannelli Mitesco.
Per strutture complesse rivolgersi all'ufficio tecnico (e-mail: project.dept@caimi.com)**

**Example of a reticular structure for the ceiling hanging of Mitesco panels.
For complex structures contact the Caimi export department (e-mail: export.dept@caimi.com)**

**Exemple de structure réticulaire pour l'accrochage au plafond des panneaux Mitesco.
Dans le cas de structures complexes, s'adresser au bureau export (e-mail: export.dept@caimi.com)**

**Ejemplo de estructura reticular para el enganche al techo de paneles Mitesco.
Para estructuras mas complejas contactar el departamento export (e-mail: export.dept@caimi.com)**

**Beispiel für die Deckenaufhängung der Mitesco-Paneele in einer netzartigen Struktur.
Für komplexe Strukturen wenden Sie sich bitte an unsere Exportabteilung
(E-Mail: export.dept@caimi.com)**

MITESCO NET

design Michele De Lucchi
Snowsound® technology by Caimi Brevetti

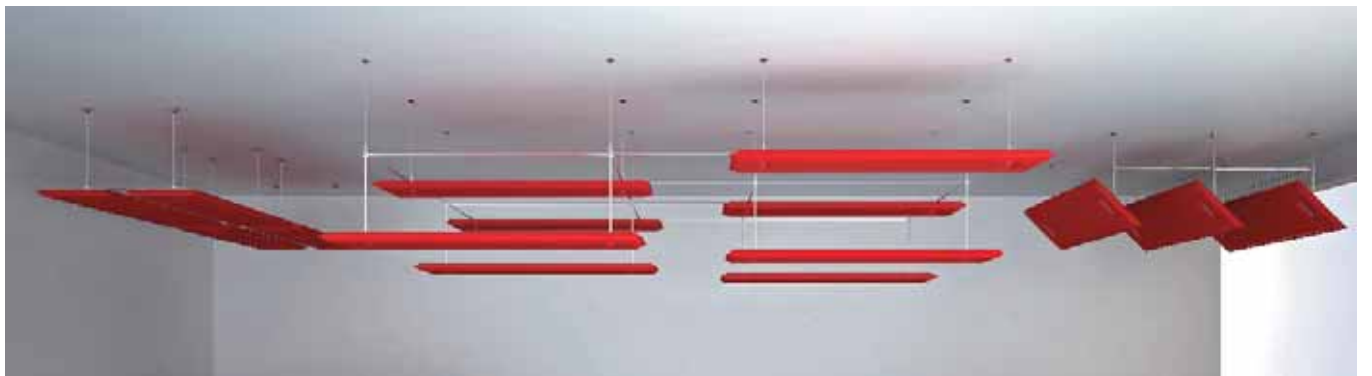
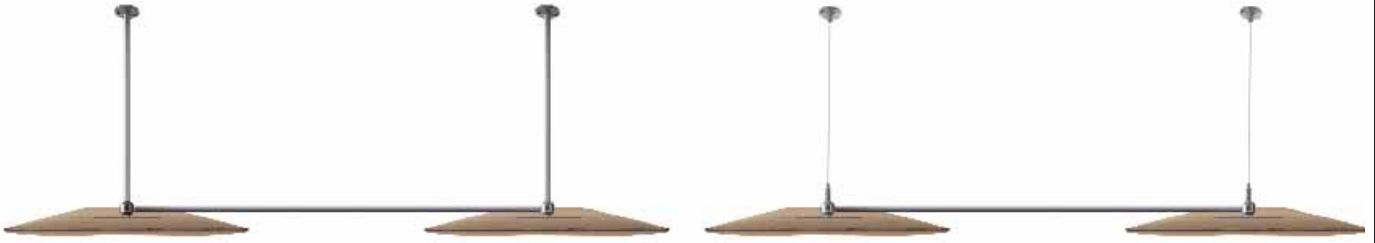

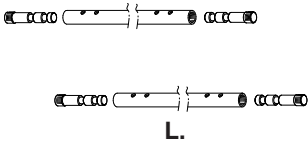
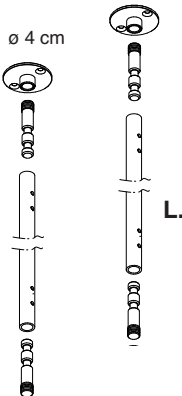
	Codice Code	Colore Colour	Prezzo Price	Descrizione Description
	7M420	Cromato Chrome-plated Chromé Cromado Verchromt	L. 20 cm	Coppia tubi in acciaio cromato disponibili in 8 lunghezze per la realizzazione di strutture reticolari per l'appendimento a soffitto dei pannelli Mitesco. I tubi vengono utilizzati orizzontalmente o verticalmente per scendere al secondo livello. Si collegano tra di loro utilizzando i giunti a 6 vie cod 7M406.
	7M437	Cromato Chrome-plated Chromé Cromado Verchromt	L. 37 cm	Pair of tubes in chrome-plated steel available in 8 lengths for the realisation of reticular structures for the ceiling hanging of Mitesco panels. The tubes are used horizontally or vertically to go down to the second level. They connect to each other by using the 6 ways joints code 7M406
	7M438	Cromato Chrome-plated Chromé Cromado Verchromt	L. 38 cm	Paire de tubes en acier chromé disponibles dans 8 longueurs pour réaliser des structures réticulaires pour l'accrochage au plafond des panneaux Mitesco. Les tubes sont utilisés horizontalement ou verticalement afin de descendre au deuxième niveau. Ils sont connectés entre eux à l'aide des joints à 6 voies réf. 7M406.
	7M447	Cromato Chrome-plated Chromé Cromado Verchromt	L. 47 cm	Par de tubos de acero cromado disponibles en 8 longitudes para la realizacion de estructuras reticulares para el enganche al techo de paneles Mitesco. Los tubos pueden ser utilizados horizontalmente o verticalmente para bajar al segundo nivel. Se conectan el uno al otro mediante la articulación a 6 vias cod 7M406.
	7M472	Cromato Chrome-plated Chromé Cromado Verchromt	L. 72 cm	1 Paar verchromte Stahlrohre verfügbar in 8 verschiedenen Längen für die Umsetzung der Deckenaufhängung von Mitesco-Paneeelen in einer netzartigen Struktur. Die Rohre werden entweder horizontal oder auch vertikal verwendet, um zwei Ebenen zu schaffen. Die Rohre werden durch den 6-Weg-Verbinder Art.Nr. 7M406 miteinander verbunden.
	7M482	Cromato Chrome-plated Chromé Cromado Verchromt	L. 82 cm	
	7M4112	Cromato Chrome-plated Chromé Cromado Verchromt	L. 112 cm	
	7M4122	Cromato Chrome-plated Chromé Cromado Verchromt	L. 122 cm	
	7M4020	Cromato Chrome-plated Chromé Cromado Verchromt	L. 20	Kit per fissaggio a soffitto della struttura reticolare composto da: 2 piastre a soffitto a 2 fori - 2 supporti (tubi) in acciaio cromato - 2 attacchi per giunti a 6 vie (7M406).
	7M4047	Cromato Chrome-plated Chromé Cromado Verchromt	L. 47	Kit for the ceiling fixing of the reticular structure composed of: 2 ceiling plates with 2 holes - 2 supports (tubes) in chrome-plated steel - 2 hangings for 6-ways joints (7M406).
	7M4082	Cromato Chrome-plated Chromé Cromado Verchromt	L. 82	Kit para el montaje al techo de la estructura reticular compuesto por: 2 placas de techo con 2 huecos - 2 soportes (tubos) de acero cromado - 2 enganches para articulaciones a 6 vias (7M406).
	7M40122	Cromato Chrome-plated Chromé Cromado Verchromt	L. 122	Set für die Deckenbefestigung der netzartigen Struktur, bestehend aus: 2 Deckenmontageplatten mit 2 Befestigungsbohrungen, 2 Halterungen (Rohre) aus verchromtem Stahl, 2 Befestigungen für d. 6-Weg-Verbinder (7M406).

MITESCO NET

design Michele De Lucchi
Snowsound® technology by Caimi Brevetti

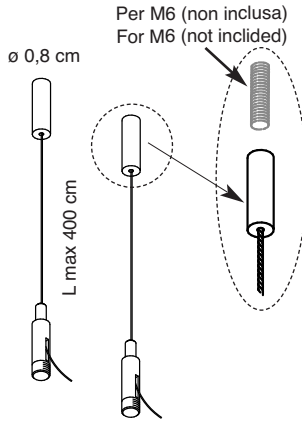
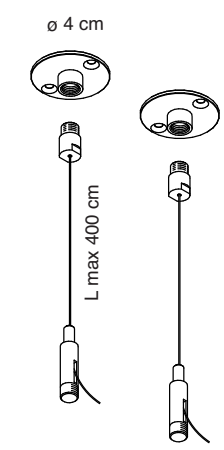
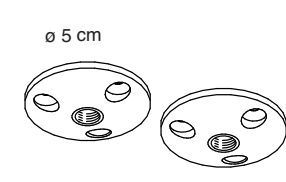
	Codice Code	Colore Colour	Prezzo Price	Descrizione Description
 <p>Per M6 (non inclusa) For M6 (not included)</p> <p>ø 0,8 cm</p> <p>L max 400 cm</p>	7M404	Cromato Chrome-plated Chromé Cromado Verchromt		<p>Kit per fissaggio a soffitto della struttura reticolare composto da: 2 attacchi a soffitto filettati M6 - 2 cavi in acciaio - 2 attacchi per giunti a 6 vie (7M406).</p> <p>Kit for the ceiling fixing of the reticular structure composed of: 2 ceiling hanging threaded M6 - 2 steel cables - 2 hangings for 6-ways joints (7M406).</p> <p>Kit d'accrochage au plafond de la structure réticulaire composé de: 2 accrochages au plafond filetés M6 - 2 câbles en acier - 2 accrochages pour joints à 6 voies (7M406).</p> <p>Kit para el montaje al techo de la estructura reticular compuesto por: 2 enganches al techo roscados M6 - 2 cables de acero, 2 enganches para articulaciones a 6 vías (7M406).</p> <p>Set für die Deckenbefestigung der netzartigen Struktur, bestehend aus: 2 Deckenbefestigungen für Gewinde M6, 2 Stahlseile, 2 Befestigungen für d. 6-Weg-Verbinder (7M406).</p>
 <p>ø 4 cm</p> <p>L max 400 cm</p>	7M4002	Cromato Chrome-plated Chromé Cromado Verchromt		<p>Kit per fissaggio a soffitto della struttura reticolare composto da: 2 piastre a soffitto a 2 fori - 2 cavi in acciaio - 2 attacchi per giunti a 6 vie (7M406).</p> <p>Kit for the ceiling fixing of the reticular structure composed of: 2 ceiling plates with 2 holes - 2 steel cables - 2 hangings for 6-ways joints (7M406).</p> <p>Kit d'accrochage au plafond de la structure réticulaire composé de: 2 plaques pour plafond à 2 trous - 2 câbles en acier - 2 accrochages pour joints à 6 voies (7M406).</p> <p>Kit para el montaje al techo de la estructura reticular compuesto por: 2 placas de techo con 2 huecos - 2 cables de acero, 2 enganches para articulaciones a 6 vías (7M406).</p> <p>Set für die Deckenbefestigung der netzartigen Struktur, bestehend aus: 2 Deckenmontageplatten mit 2 Befestigungsbohrungen, 2 Stahlseile, 2 Befestigungen für d. 6-Weg-Verbinder (7M406).</p>
 <p>ø 5 cm</p>	7M403 OPZIONALE OPTIONAL	Cromato Chrome-plated Chromé Cromado Verchromt		<p>Coppia piastre a soffitto a 3 fori. Possono essere acquistate separatamente e utilizzate per sostituire gli attacchi a 2 fori in tutti i kit di fissaggio a soffitto. ARTICOLO OPZIONALE.</p> <p>Pair of ceiling plates with 3 holes. Can be purchased separately and be used to replace the plates with 2 holes in all ceiling hanging kits. OPTIONAL ITEM.</p> <p>Paire de plaques pour plafond à 3 trous. Il est possible de les acheter séparément et les utiliser pour remplacer les accroches à 2 trous dans tous les kits d'accrochage au plafond. ARTICLE OPTIONNEL</p> <p>Par de placas de techo con 3 huecos. Se pueden comprar separatamente y ser utilizadas para reemplazar los enganches a 2 huecos en todos los kit de montaje al techo. ARTÍCULO OPCIONAL</p> <p>2 Deckenmontageplatten mit 3 Befestigungsbohrungen. Diese können separat gekauft und an Stelle der Befestigungen mit 2 Bohrungen in allen Deckenbefestigungs-Sets verwendet werden. ERHALTLICH</p>

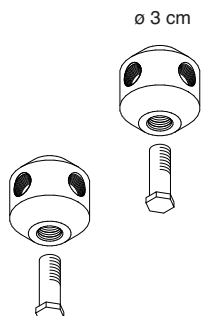
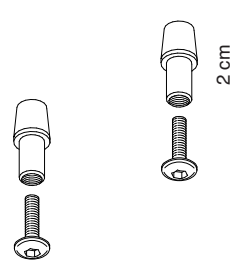
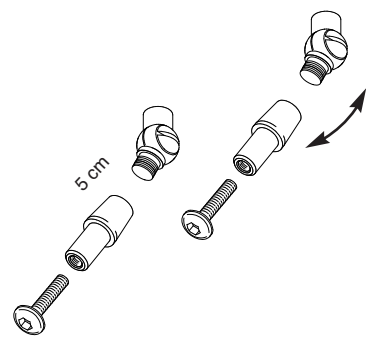
	Codice Code	Colore Colour	Prezzo Price	Descrizione Description
 <p>ø 3 cm</p>	7M406	Cromato Chrome-plated Chromé Cromado Verchromt	1 coppia / 1 pair 1 paire / 1 pare 1 Paar	<p>Coppia giunti a 6 vie per collegamento dei tubi cod. 7M420 / 7M437 / 7M438 / 7M447 / 7M472 / 7M482 / 7M4112 / 7M4122 per la realizzazione di strutture reticolari. Il pannello può essere fissato direttamente al giunto utilizzando le viti in dotazione.</p> <p>Pair of 6 ways joints for connection of the tubes code 7M420 / 7M437 / 7M438 / 7M447 / 7M472 / 7M482 / 7M4112 / 7M4122 for the realization of reticular structures. The panel can be fixed directly to the joint by using the provided screws.</p> <p>Paire de joints à 6 voies pour l'accrochage des tubes réf. 7M420 / 7M437 / 7M438 / 7M447 / 7M472 / 7M482 / 7M4112 / 7M4122 pour la réalisation de structures réticulaires. On peut fixer le panneau directement au joint par les vis incluses.</p> <p>Par de articulaciones a 6 vias para la connexion de tubos cod. 7M420 / 7M437 / 7M438 / 7M447 / 7M472 / 7M482 / 7M4112 / 7M4122 para la realización de estructuras reticulares. El panel puede ser enganchado directamente a la articulación utilizando los tornillos suministrados.</p> <p>1 Paar 6-Weg-Verbinder für die Verbindung der Rohre Art. Nr. 7M420 / 7M437 / 7M438 / 7M447 / 7M472 / 7M482 / 7M4112 / 7M4122 zur Umsetzung netzartiger Strukturen. Das Paneel kann durch die Verwendung der beiliegenden Schrauben direkt an dem Verbindungsstück befestigt werden.</p>
 <p>2 cm</p>	7M407	Cromato Chrome-plated Chromé Cromado Verchromt		<p>Coppia adapter per collegamento del pannello ai tubi cod. 7M420 / 7M437 / 7M438 / 7M447 / 7M472 / 7M482 / 7M4112 / 7M4122 da utilizzare in assenza di giunto a 6 vie (7M406).</p> <p>Pair of adapters for the connection of the panel to the tubes code 7M420 / 7M437 / 7M438 / 7M447 / 7M472 / 7M482 / 7M4112 / 7M4122 to be used in absence of the 6 ways joint (7M406).</p> <p>Paire d'adaptateurs pour l'accrochage du panneau aux tubes réf. 7M420 / 7M437 / 7M438 / 7M447 / 7M472 / 7M482 / 7M4112 / 7M4122 à utiliser au cas d'absence du joint à 6 voies (7M406).</p> <p>Par de adaptadores para la conexión del panel a los tubos cod. 7M420 / 7M437 / 7M438 / 7M447 / 7M472 / 7M482 / 7M4112 / 7M4122 utilizar en ausencia de la articulación a 6 vias (7M406).</p> <p>1 Paar Adapter für die Verbindung der Paneele mit den Rohren Art. Nr. 7M420 / 7M437 / 7M438 / 7M447 / 7M472 / 7M482 / 7M4112 / 7M4122, zu benutzen wenn nicht der 6-Weg-Verbinder (7M406) verwendet wird.</p>
 <p>5 cm</p>	7M4005	Cromato Chrome-plated Chromé Cromado Verchromt		<p>Coppia snodi per collegamento del pannello ai tubi cod. 7M420 / 7M437 / 7M438 / 7M447 / 7M472 / 7M482 / 7M4112 / 7M4122. Da utilizzare in assenza di giunto a 6 vie (7M406) per dare l'inclinazione desiderata al pannello.</p> <p>Pair of articulated joints for the connection of the panel to the tubes code 7M420 / 7M437 / 7M438 / 7M447 / 7M472 / 7M482 / 7M4112 / 7M4122. To be used in absence of the 6 ways joint (7M406) to give the desired inclination to the panel.</p> <p>Paire d'articulations pour l'accrochage du panneau aux tubes réf. 7M420 / 7M437 / 7M438 / 7M447 / 7M472 / 7M482 / 7M4112 / 7M4122. A utiliser au cas d'absence de joints à 6 voies (7M406) pour donner au panneau l'inclinaison souhaitée.</p> <p>Par de articulaciones móviles para la conexión del panel a los tubos cod. 7M420 / 7M437 / 7M438 / 7M447 / 7M472 / 7M482 / 7M4112 / 7M4122. Utilizar en ausencia de la articulación a 6 vias (7M406) para dar la inclinación deseada al panel.</p> <p>1 Paar Gelenke für die Verbindung der Paneele mit den Rohren Art. Nr. 7M420 / 7M437 / 7M438 / 7M447 / 7M472 / 7M482 / 7M4112 / 7M4122. Zu benutzen, um dem Paneel den gewünschten Neigungswinkel zu geben, wenn nicht der 6-Weg-Verbinder (7M406) verwendet wird.</p>

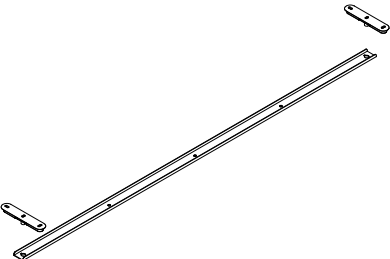
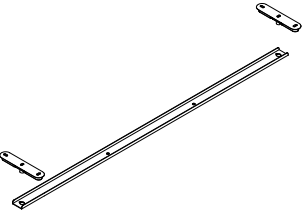
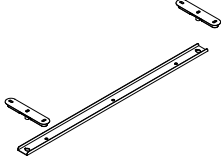
	Codice Code	Colore Colour	Prezzo Price	Descrizione Description
	<p>7M160-GA</p>	<p>Grigio argento Silver grey Gris argenté Gris plata Silbergrau</p>	<p>Per pannelli For panels L. 159 cm</p>	<p>Profilo livellatore in acciaio verniciato con polveri epossidiche e tecnopolimero per 1 pannello Mitesco: 7M1016-XXXX, 7M1016BO-XXXX (XXXX = Variante colore). Utilizzare sempre in caso di fissaggio del pannello al soffitto in posizione orizzontale (parallela al piano).</p> <p>Leveler profile in powder coated steel and high-tech polymer for 1 Mitesco panel code: 7M1016-XXXX, 7M1016BO-XXXX (XXXX = colour option). To be always used in case of fixation of the panel to the ceiling in horizontal position (parallel to the floor).</p> <p>Profil niveleur en acier peint en époxy et technopolymère pour un panneau Mitesco: 7M1016-XXXX, 7M1016BO-XXXX (XXXX = option couleur). Toujours à prévoir en cas d'accrochage du panneau au plafond en position horizontale (parallèle à la surface).</p> <p>Perfil nivelador de acero recubierto epoxi y polímero para 1 panel Mitesco cod. 7M1016-XXXX, 7M1016BO-XXXX (XXXX = opción color). Utilizar siempre en caso de enganche del panel al techo en posición horizontal (paralelo al plano).</p> <p>Justierungsprofil aus pulverbeschichtetem Stahl und Technopolymer für 1 Mitesco-Paneel Art.-Nr. 7M1016-XXXX, 7M1016BO-XXXX (XXXX = Farbvariante). Immer verwenden wenn das Paneel in horizontaler Position an der Decke befestigt wird. (Parallel zur Ebene).</p>
	<p>7M120-GA</p>	<p>Grigio argento Silver grey Gris argenté Gris plata Silbergrau</p>	<p>Per pannelli For panels L. 119 cm</p>	<p>Profilo livellatore in acciaio verniciato con polveri epossidiche e tecnopolimero per 1 pannello Mitesco: 7M1012-XXXX, 7M1012BO-XXXX (XXXX = Variante colore). Utilizzare sempre in caso di fissaggio del pannello al soffitto in posizione orizzontale (parallela al piano).</p> <p>Leveler profile in powder coated steel and high-tech polymer for 1 Mitesco panel code: 7M1012-XXXX, 7M1012BO-XXXX (XXXX = colour option). To be always used in case of fixation of the panel to the ceiling in horizontal position (parallel to the floor).</p> <p>Profil niveleur en acier peint en époxy et technopolymère pour un panneau Mitesco: 7M1012-XXXX, 7M1012BO-XXXX (XXXX = option couleur). Toujours à prévoir en cas d'accrochage du panneau au plafond en position horizontale (parallèle à la surface).</p> <p>Perfil nivelador de acero recubierto epoxi y polímero para 1 panel Mitesco cod. 7M1012-XXXX, 7M1012BO-XXXX (XXXX = opción color). Utilizar siempre en caso de enganche del panel al techo en posición horizontal (paralelo al plano).</p> <p>Justierungsprofil aus pulverbeschichtetem Stahl und Technopolymer für 1 Mitesco-Paneel Art.-Nr. 7M1012-XXXX, 7M1012BO-XXXX (XXXX = Farbvariante). Immer verwenden wenn das Paneel in horizontaler Position an der Decke befestigt wird. (Parallel zur Ebene).</p>
	<p>7M80-GA</p>	<p>Grigio argento Silver grey Gris argenté Gris plata Silbergrau</p>	<p>Per pannelli For panels L. 75 cm</p>	<p>Profilo livellatore in acciaio verniciato con polveri epossidiche e tecnopolimero per 1 pannello Mitesco: 7M1008-XXXX, 7M1008BO-XXXX (XXXX = Variante colore). Utilizzare sempre in caso di fissaggio del pannello al soffitto in posizione orizzontale (parallela al piano).</p> <p>Leveler profile in powder coated steel and high-tech polymer for 1 Mitesco panel code: 7M1008-XXXX, 7M1008BO-XXXX (XXXX = colour option). To be always used in case of fixation of the panel to the ceiling in horizontal position (parallel to the floor).</p> <p>Profil niveleur en acier peint en époxy et technopolymère pour un panneau Mitesco: 7M1008-XXXX, 7M1008BO-XXXX (XXXX = option couleur). Toujours à prévoir en cas d'accrochage du panneau au plafond en position horizontale (parallèle à la surface).</p> <p>Perfil nivelador de acero recubierto epoxi y polímero para 1 panel Mitesco cod. 7M1008-XXXX, 7M1008BO-XXXX (XXXX = opción color). Utilizar siempre en caso de enganche del panel al techo en posición horizontal (paralelo al plano).</p> <p>Justierungsprofil aus pulverbeschichtetem Stahl und Technopolymer für 1 Mitesco-Paneel Art.-Nr. 7M1008-XXXX, 7M1008BO-XXXX (XXXX = Farbvariante). Immer verwenden wenn das Paneel in horizontaler Position an der Decke befestigt wird. (Parallel zur Ebene).</p>

MITESCO DESK

design Michele De Lucchi
Snowsound® technology by Caimi Brevetti

PER APPLICAZIONI A SCRIVANIA - DESK MOUNTING - MONTAGE SUR LE BUREAU -
MONTAJE SOBRE MESAS DE ESCRITORIO - TISCHBEFESTIGUNG

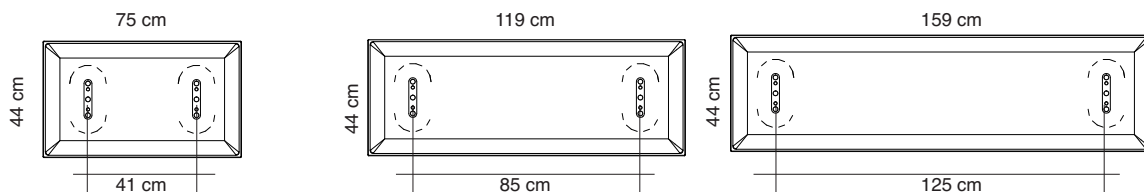

	Codice/Code Prezzo/Price	Codice/Code Prezzo/Price	Codice/Code Prezzo/Price
Bianco White Blanc 0001	7M084-0001	7M124-0001	7M164-0001
Grigio argento Silver grey Gris argenté 8004	7M084-8004	7M124-8004	7M164-8004
Grigio scuro Dark grey Gris foncé 8007	7M084-8007	7M124-8007	7M164-8007
Beige Beige Beige 1008	7M084-1008	7M124-1008	7M164-1008
Tortora Dove-grey Taupe 2005	7M084-2005	7M124-2005	7M164-2005
Giallo Yellow Jaune 3008	7M084-3008	7M124-3008	7M164-3008
Arancione Orange Orange 4030	7M084-4030	7M124-4030	7M164-4030
Rosso Red Rouge 4027	7M084-4027	7M124-4027	7M164-4027
Verde chiaro Light green Vert clair 7004	7M084-7004	7M124-7004	7M164-7004
Verde Green Vert 7013	7M084-7013	7M124-7013	7M164-7013
Blu Blue Bleu 6071	7M084-6071	7M124-6071	7M164-6071
Nero Black Noir 8033	7M084-8033	7M124-8033	7M164-8033

MITESCO DESK

design Michele De Lucchi
Snowsound® technology by Caimi Brevetti

Codice Code	Colore Colour	Prezzo Price	Descrizione Description
7M511-GA	Grigio argento Silver grey Gris argenté Gris plata Silbergrau	1 coppia / 1 pair 1 paire / 1 pare 1 Paar	Coppia staffe in acciaio verniciato con polveri epossidiche per fissaggio sopra il piano della scrivania tramite viti (non incluse). Attacchi al pannello Mitesco e coperture in tecnopolimero grigio o bianco. Per pannelli Mitesco Desk pag. 56.
7M511-BO	Bianco opaco Mat white Blanc mat Blanco mate Mattweiß	1 coppia / 1 pair 1 paire / 1 pare 1 Paar	Paire d'étriers en acier peint époxy pour fixation sur le bureau par des vis (pas incluses). Jonctions au panneau Mitesco et couvertures en technopolymère gris ou blanc. Pour Mitesco Desk panneaux page 56.
			Par de abrazaderas de acero recubierto epoxi para fijación sobre el plan del escritorio por medio de tornillos (no incluydos). Enganches al panel Mitesco y coberturas de polímero gris o blanco. Para Mitesco Desk panels pag. 56.
			1 Paar Halterungen aus pulverbeschichtetem Stahl zur Befestigung auf der Tischplatte durch Schrauben (nicht inkludiert). Mitesco-Panelbefestigungen und Abdeckungen aus grauem oder weissem Technopolymer. Für Mitesco Desk Paneele, Seite 56.

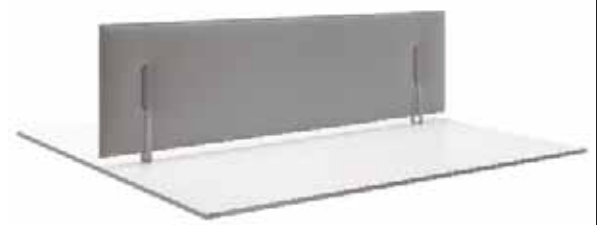
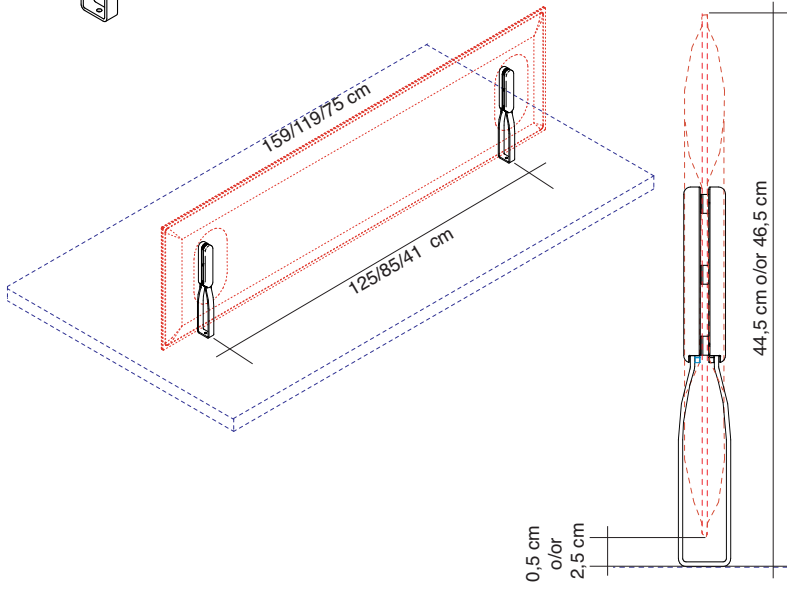
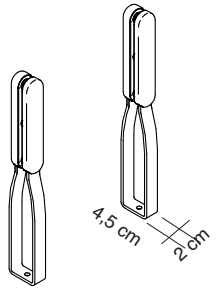

7S100-GA	Grigio argento Silver grey Gris argenté Gris plata Silbergrau	1 coppia / 1 pair 1 paire / 1 pare 1 Paar	Da utilizzare con staffe 7M511-GA / 7M511-BO. To be used with brackets 7M511-GA / 7M511-BO. Utiliser avec étriers 7M511-GA / 7M511-BO.
7S100-BO	Bianco opaco Mat white Blanc mat Blanco mate Mattweiß	1 coppia / 1 pair 1 paire / 1 pare 1 Paar	Utilización con abrazaderas 7M511-GA / 7M511-BO. Zur Verwendung mit den Halterungen 7M511-GA / 7M511-BO.

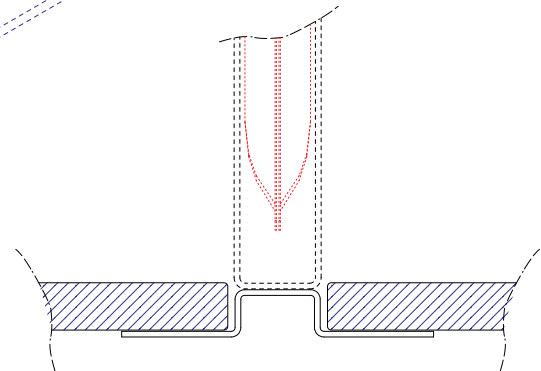
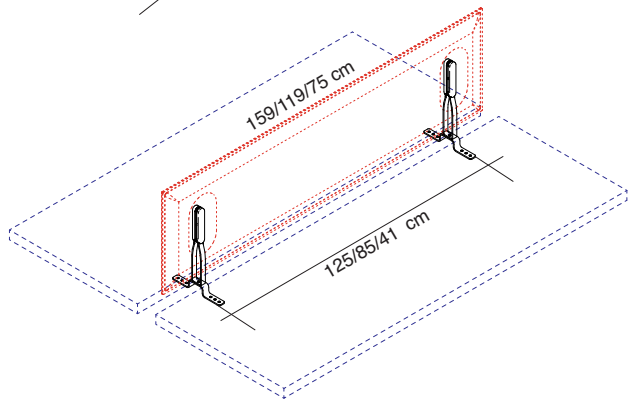
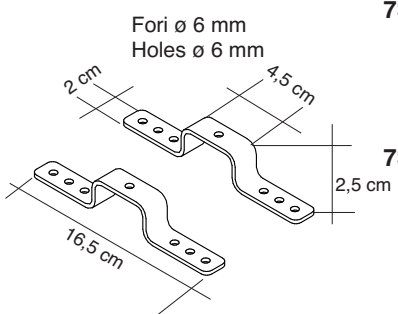

MITESCO DESK



design Michele De Lucchi
Snowsound® technology by Caimi Brevetti

Codice Code	Colore Colour	Prezzo Price	Descrizione Description
7M5100-GA	Grigio argento Silver grey Gris argenté Gris plata Silbergrau	1 coppia / 1 pair 1 paire / 1 pare 1 Paar	Coppia staffe con morsetto in acciaio verniciato con polveri epossidiche per fissaggio al piano della scrivania. Attacchi al pannello Mitesco e coperture in tecnopolimero grigio o bianco. Per pannelli Mitesco Desk pag. 56.
7M5100-BO	Bianco opaco Mat white Blanc mat Blanco mate Mattweiß	1 coppia / 1 pair 1 paire / 1 pare 1 Paar	Pair of brackets with clamp in powder-coated steel for connection to the desk top. Mitesco panel connections and front covers in grey or white high-tech polymer. For Mitesco Desk panels page 56.
			<p>Paire d'étriers avec étau en acier peint époxy pour fixation au bureau. Jonctions au panneau Mitesco et couvertures en technopolymère gris ou blanc. Pour Mitesco Desk panneaux page 56.</p> <p>Par de abrazaderas con sujetador de acero recubierto epoxi para fijación al plan del escritorio. Enganches al panel Mitesco y coberturas de polímero gris o blanco. Para Mitesco Desk panels pag. 56.</p> <p>1 Paar Halterungen aus pulverbeschichtetem Stahl mit Klemmen zur Befestigung an der Tischplatte. Mitesco-Panelbefestigungen und Abdeckungen aus grauem oder weissem Technopolymer. Für Mitesco Desk Paneele, Seite 56.</p>

7M515-GA	Grigio argento Silver grey Gris argenté Gris plata Silbergrau	1 coppia / 1 pair 1 paire / 1 pare 1 Paar	Coppia staffe in acciaio verniciato con polveri epossidiche per fissaggio sotto il piano della scrivania tramite viti (non incluse). Attacchi al pannello Mitesco e coperture in tecnopolimero grigio o bianco. Per pannelli Mitesco Desk pag. 56.
7M515-BO	Bianco opaco Mat white Blanc mat Blanco mate Mattweiß	1 coppia / 1 pair 1 paire / 1 pare 1 Paar	Pair of brackets in powder-coated steel to be fixed under the desk top with screws (not included). Mitesco panel connections and front covers in grey or white high-tech polymer. For Mitesco Desk panels page 56.
			<p>Paire d'étriers en acier peint époxy pour fixation sous le bureau par des vis (pas incluses). Jonctions au panneau Mitesco et couvertures en technopolymère gris ou blanc. Pour Mitesco Desk panneaux page 56.</p> <p>Par de abrazaderas de acero recubierto epoxi para fijación debajo el plan del escritorio por medio de tornillos (no incluidos). Enganches al panel Mitesco y coberturas de polímero gris o blanco. Para Mitesco Desk panels pag. 56.</p> <p>1 Paar Halterungen aus pulverbeschichtetem Stahl zur Befestigung unter der Tischplatte durch Schrauben (nicht inkludiert). Mitesco-Panelbefestigungen und Abdeckungen aus grauem oder weissem Technopolymer. Für Mitesco Desk Paneele, Seite 56.</p>

MITESCO DESK

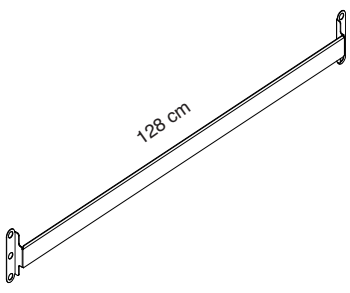
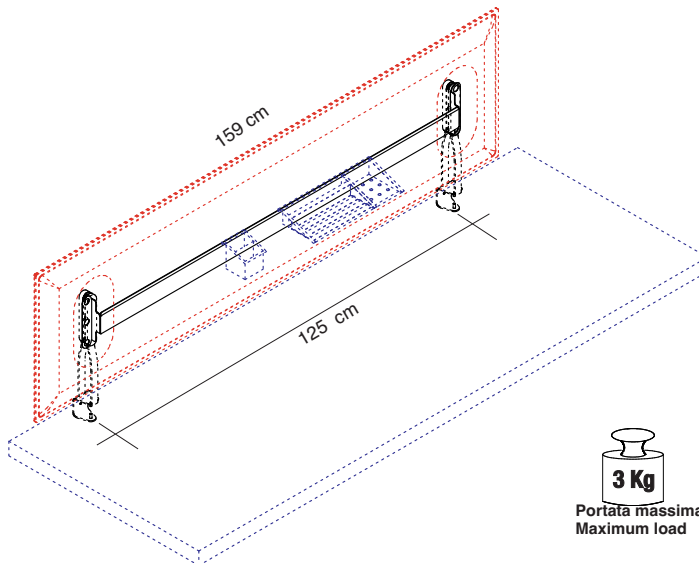
design Michele De Lucchi
Snowsound® technology by Caimi Brevetti

	Codice Code	Colore Colour	Prezzo Price	Descrizione Description
	7M546-GA	Grigio argento Silver grey Gris argenté Gris plata Silbergrau		Barra porta accessori Desk-up realizzata in acciaio verniciato con polveri epossidiche. Da utilizzare con staffe 7M5100-GA / 7M5100-BO / 7M515-GA / 7M515-BO
	7M546-BO	Bianco opaco Mat white Blanc mat Blanco mate Mattweiß		Epoxy powder-coated steel toolbar for Desk Up accessories. To be used with brackets 7M5100-GA / 7M5100-BO / 7M515-GA / 7M515-BO.
				Profile pour accessoires Desk-up en acier peint en époxy. Utiliser avec étriers 7M5100-GA / 7M5100-BO / 7M515-GA / 7M515-BO.
				Perfil para acesorios Desk-Up realizado de acero recubierto epoxi. Utilizacion con abrazaderas 7M5100-GA / 7M5100-BO / 7M515-GA / 7M515-BO.
				Systemeschiene aus pulverbeschichtetem Stahl für Desk Up-Schalen. Zur Verwendung mit den Halterungen 7M5100-GA / 7M5100-BO / 7M515-GA / 7M515-BO.
				 <p>1 code 7M515-GA / 7M515-BO o/or 7M5100-GA / 7M5100-BO</p> <p>2 code 7M546-GA / 7M546-BO</p>
			 <p>3 Kg Portata massima Maximum load</p>	



MITESCO DESK

design Michele De Lucchi
Snowsound® technology by Caimi Brevetti

Codice Code	Colore Colour	Prezzo Price	Descrizione Description
7M517-GA	Grigio argento Silver grey Gris argenté Gris plata Silbergrau	1 coppia / 1 pair 1 paire / 1 pare 1 Paar	Coppia staffe con base in acciaio verniciato con polveri epossidiche per fissaggio al piano della scrivania. Fissaggio al piano obbligatorio a cura del cliente. Scegliere il tipo di fissaggio / incollaggio idoneo alla superficie del piano. Attacchi al pannello Mitesco e coperture in tecnopolimero grigio o bianco. Per pannelli Mitesco Desk pag. 56.
7M517-BO	Bianco opaco Mat white Blanc mat Blanco mate Mattweiß	1 coppia / 1 pair 1 paire / 1 pare 1 Paar	Pair of brackets with base in powder coated steel for fixing to the desk top. Mandatory fastening to the top at customer's care. Choose the most suitable connection/gluing the for the surface. Mitesco panel connections and front covers in grey or white high-tech polymer. For Mitesco Desk panels page 56.
7M519-GA	Grigio argento Silver grey Gris argenté Gris plata Silbergrau	1 coppia / 1 pair 1 paire / 1 pare 1 Paar	Coppia staffe con base in acciaio verniciato con polveri epossidiche per appoggio al piano della scrivania. Attacchi al pannello Mitesco e coperture in tecnopolimero grigio o bianco. Per pannelli Mitesco Desk pag. 56.
7M519-BO	Bianco opaco Mat white Blanc mat Blanco mate Mattweiß	1 coppia / 1 pair 1 paire / 1 pare 1 Paar	Pair of brackets with base in powder coated steel for desk top stand. Mitesco panel connections and front covers in grey or white high-tech polymer. For Mitesco Desk panels page 56.

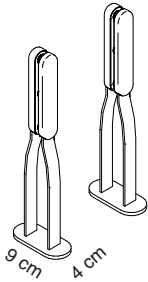

7M517-BO

Bianco opaco
Mat white
Blanc mat
Blanco mate
Mattweiß

1 coppia / 1 pair
1 paire / 1 pare
1 Paar

Pair of brackets with base in powder coated steel for fixing to the desk top. Mandatory fastening to the top at customer's care. Choose the most suitable connection/gluing the for the surface. Mitesco panel connections and front covers in grey or white high-tech polymer. **For Mitesco Desk panels page 56.**

Paire d'étriers avec base en acier peint en époxy à fixer au dessus du bureau. Fixation au dessus obligatoire de la part du client. Choisir le type d'accrochage/collage adapté à la surface du dessus. Accrochages au panneau Mitesco et couvertures en technopolymère gris ou blanc. **Pour Mitesco Desk panneaux page 56.**

Par de embrazaderas con base de acero recubierto epoxi para fijacion al plan del escritorio. Enganche al plano obligatorio por parte del cliente. Elegir el tipo de sujetador / enlace lo mas adecuado para la superficie del plano. Enganches al panel Mitesco y coberturas en polimero gris o blanco. **Para Mitesco Desk panels pag. 56.**

1 Paar Halterungen mit Standfüßen aus pulverbeschichtetem Stahl zur Befestigung auf der Tischplatte. Befestigung durch den Kunden unbedingt erforderlich. Wählen Sie die am besten geeignete Art der Verbindung/Verklebung für die betreffende Oberfläche. Mitesco-Paneelbefestigungen und Abdeckungen aus grauem oder weißem Technopolymer. **Für Mitesco Desk Paneele, Seite 56.**

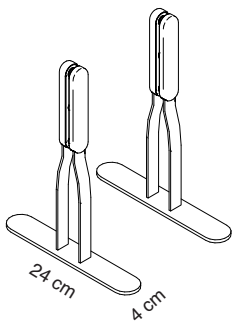
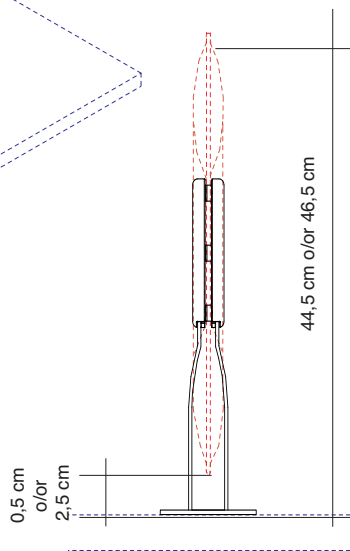
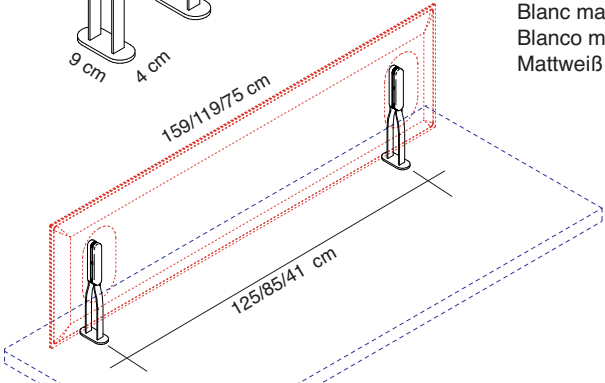

7M519-GA

Grigio argento
Silver grey
Gris argenté
Gris plata
Silbergrau

1 coppia / 1 pair
1 paire / 1 pare
1 Paar

Coppia staffe con base in acciaio verniciato con polveri epossidiche per appoggio al piano della scrivania. Attacchi al pannello Mitesco e coperture in tecnopolimero grigio o bianco. **Per pannelli Mitesco Desk pag. 56.**

Pair of brackets with base in powder coated steel for desk top stand. Mitesco panel connections and front covers in grey or white high-tech polymer. **For Mitesco Desk panels page 56.**

Paire d'étriers avec base en acier peint en époxy à poser sur le dessus du bureau. Accrochages au panneau Mitesco et couvertures en technopolymère gris ou blanc. **Pour Mitesco Desk panneaux page 56.**

Par de embrazaderas con base de acero recubierto epoxi para apoyar al escritorio. Enganches al panel Mitesco y coberturas en polimero gris o blanco. **Para Mitesco Desk panels pag. 56.**

Paar Halterungen mit Standfüßen aus pulverbeschichtetem Stahl zur Aufstellung auf der Tischplatte. Mitesco-Paneelbefestigungen und Abdeckungen aus grauem oder weißem Technopolymer. **Für Mitesco Desk Paneele, Seite 56.**

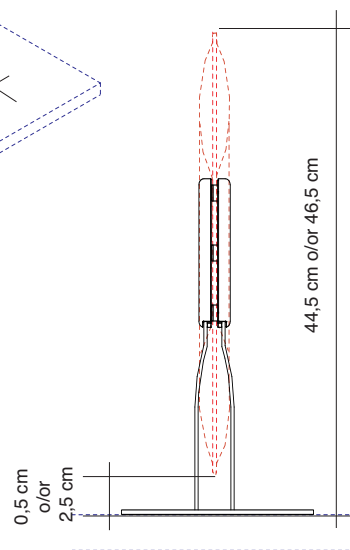
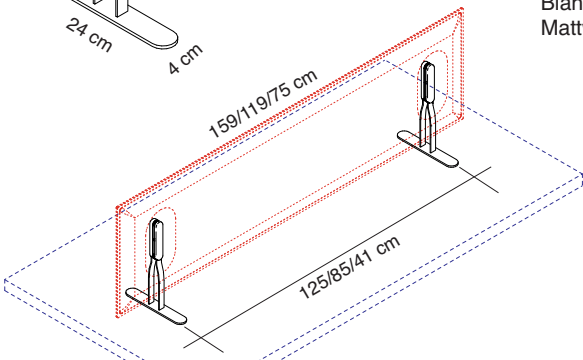

MITESCO DESK

design Michele De Lucchi
Snowsound® technology by Caimi Brevetti

Codice Code	Colore Colour	Prezzo Price	Descrizione Description
7M518-GA	Grigio argento Silver grey Gris argenté Gris plata Silbergrau	1 coppia / 1 pair 1 paire / 1 pare 1 Paar	Coppia staffe con base in acciaio verniciato con polveri epossidiche per appoggio al piano della scrivania. Attacchi al pannello Mitesco e coperture in tecnopolimero grigio o bianco. Per pannelli Mitesco Desk pag. 56.
7M518-BO	Bianco opaco Mat white Blanc mat Blanco mate Mattweiß	1 coppia / 1 pair 1 paire / 1 pare 1 Paar	Pair of brackets with base in powder coated steel for desk top stand. Mitesco panel connections and front covers in grey or white high-tech polymer. For Mitesco Desk panels page 56. Paire d'étriers avec base en acier peint en époxy à poser sur le dessus du bureau. Accrochages au panneau Mitesco et couvertures en technopolymère gris ou blanc. Pour Mitesco Desk panneaux page 56. Par de abrazaderas con base de acero recubierto epoxi para apoyar al escritorio. Enganches al panel Mitesco y coberturas en polímero gris o blanco. Para Mitesco Desk panels pag. 56. Paar Halterungen mit Standfüßen aus pulverbeschichtetem Stahl zur Aufstellung auf der Tischplatte. Mitesco-Paneelbefestigungen und Abdeckungen aus grauem oder weißem Technopolymer. Für Mitesco Desk Paneele, Seite 56.

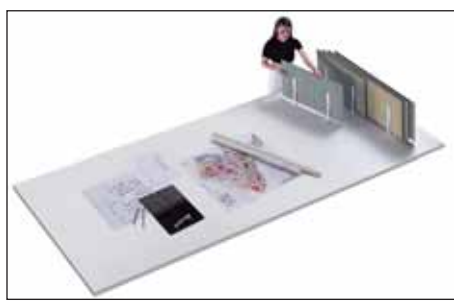
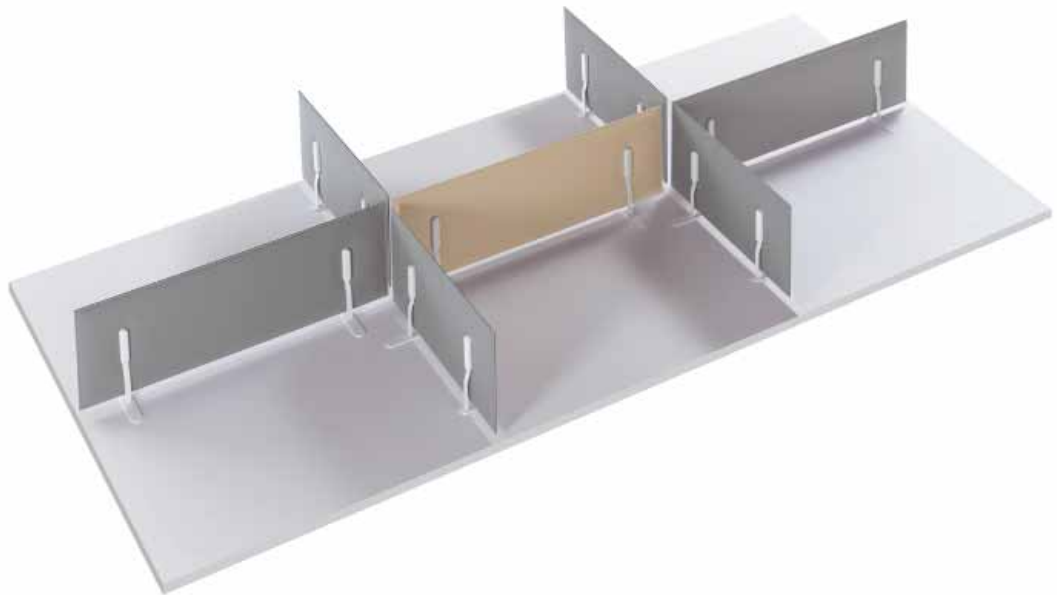
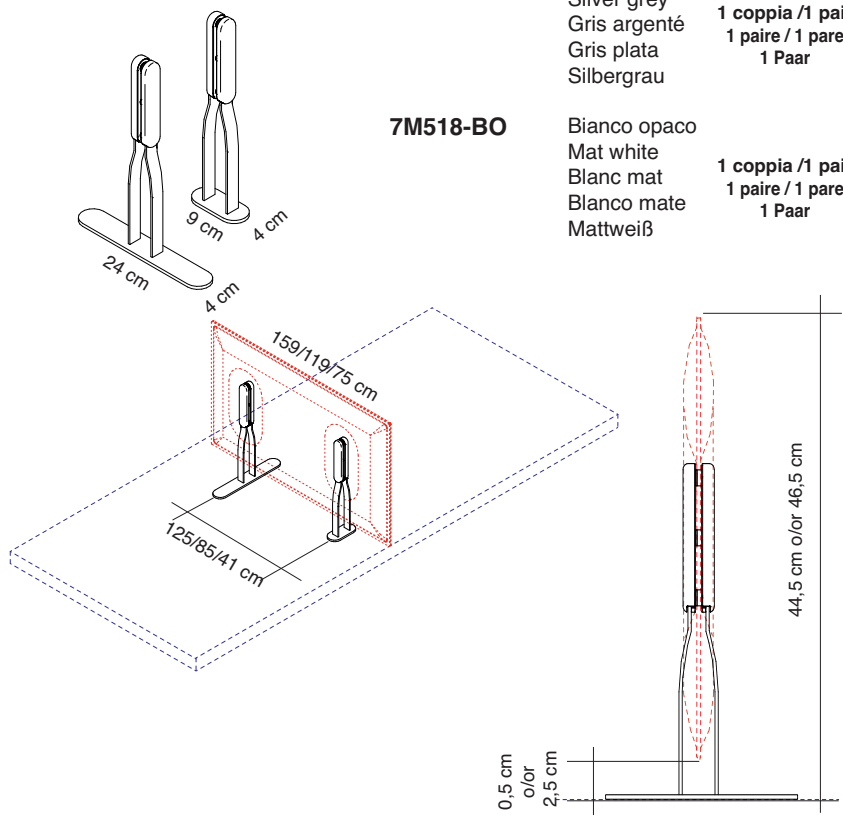

MITESCO DESK

design Michele De Lucchi
Snowsound® technology by Caimi Brevetti

Codice Code	Colore Colour	Prezzo Price	Descrizione Description
----------------	------------------	-----------------	----------------------------

7M520-GA

Grigio argento
Silver grey
Gris argenté
Gris plata
Silbergrau

Coppia staffe con morsetto in acciaio verniciato con polveri epossidiche per fissaggio al piano della scrivania.
Attacchi al pannello Mitesco e coperture in tecnopolimero grigio o bianco. **PER DUE PANNELLI Mitesco Desk pag. 56.**

7M520-BO

Bianco opaco
Mat white
Blanc mat
Blanco mate
Mattweiß

Pair of brackets with clamp in powder-coated steel for connection to the desk top.

Mitesco panel connections and front covers in grey or white high-tech polymerl. **FOR TWO Mitesco Desk PANELS page 56.**

Paire d'étriers avec étau en acier peint époxy pour fixation au bureau. Jonctions au panneau Mitesco et couvertures en technopolymère gris ou blanc.

POUR DEUX Mitesco Desk PANNEAUX page 56.

Par de abrazaderas con sujetador en acero recubierto epoxi para fijacion al plan del escritorio.

Enganches al panel Mitesco y cobertures de polímero gris o blanco. **PARA DOS Mitesco Desk PANELS pag. 56.**

1 Paar Halterungen aus pulverbeschichtetem Stahl mit Klemmen zur Befestigung an der Tischplatte.

Mitesco-Paneelbefestigungen und Abdeckungen aus grauem oder weissem Technopolymer.

FUR ZWEI Mitesco Desk PANEELE, Seite 56.

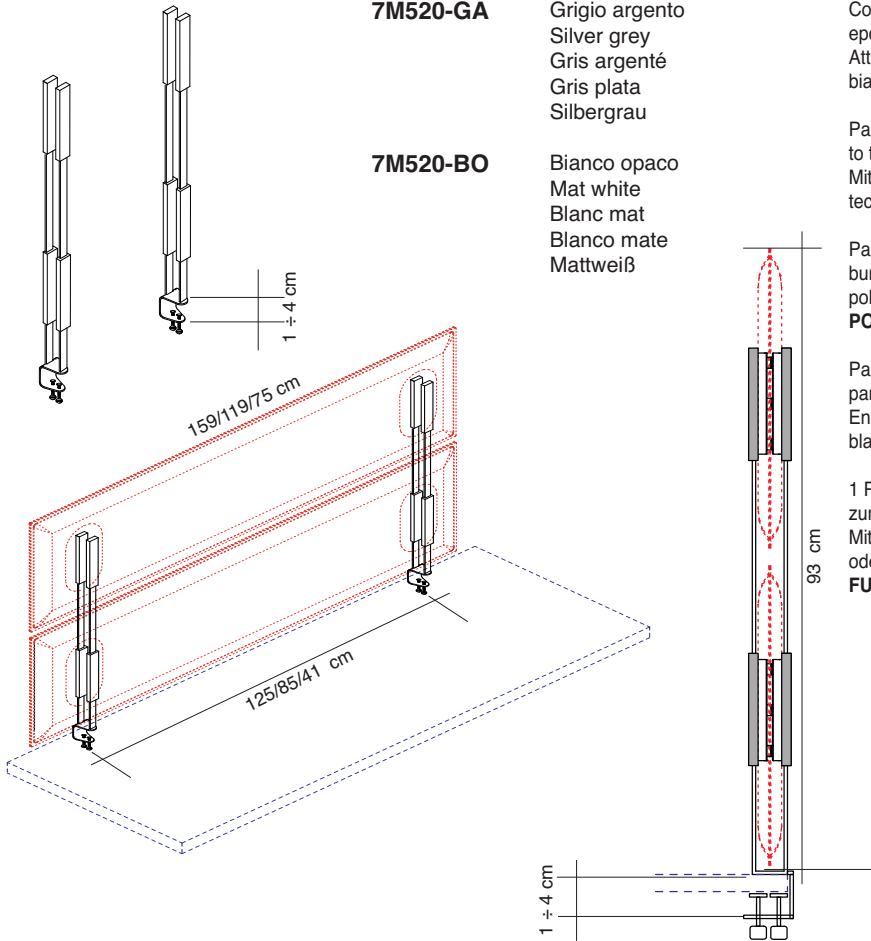

Codice Code	Colore Colour	Prezzo Price	Descrizione Description
7M531-GA	Grigio argento Silver grey Gris argenté Gris plata Silbergrau	1 coppia / 1 pair 1 paire / 1 pare 1 Paar	<p>Coppia attacchi regolabili in acciaio verniciato con polveri epossidiche per pareti già esistenti. Non adatti per pareti in vetro e/o materiali fragili o poco resistenti. Per pannelli Mitesco pag. 9/10/11.</p> <p>Pair of adjustable brackets in powder coated steel for existing partitions. Not suitable for glass or fragile partitions. For Mitesco panels page 9/10/11.</p> <p>Paire d'accrochages réglables en acier peint en époxy pour cloisons déjà en place. Ils ne sont pas adaptés aux cloisons en verre et/ou matériaux fragiles ou peu résistants. Pour Mitesco panneaux page 9/10/11.</p> <p>Par de abrazaderas regulables con base de acero recubierto epoxi para particiones ya existentes. No adecuado para particiones en vidrio o materiales frágiles. Para panel Mitesco. Para Mitesco panels pag. 9/10/11.</p> <p>1 Paar verstellbare Befestigungen aus pulverbeschichtetem Stahl zur Aufhängung an Trennwänden. Nicht geeignet für Trennwände aus Glas und/oder zerbrechlichen bzw. nicht widerstandsfähigen Materialien. Zur Verwendung mit Mitesco-Paneelen. Für Mitesco Paneele, Seite 9/10/11.</p>

Spessore massimo parete 6 cm
Max. depth of the partition 6 cm

0 ± 6 cm

0 ± 15 cm

44 cm

7M535-GA	Grigio argento Silver grey Gris argenté Gris plata Silbergrau	1 coppia / 1 pair 1 paire / 1 pare 1 Paar	<p>Coppia agganci regolabili in acciaio verniciato con polveri epossidiche per profili (tipo Desk-Up). Per pannelli Mitesco pag. 9/10/11.</p> <p>Pair of adjustable hooks in powder coated steel for profiles (Desk-Up kind). For Mitesco panels pages 9/10/11.</p> <p>Paire d'accrochages réglables en acier peint en époxy pour profils (type Desk-Up). Pour Mitesco panneaux page 9/10/11.</p> <p>Par de enganches regulables de acero recubierto epoxi para perfiles (tipo Desk-Up). Para panel Mitesco. Para Mitesco panels pag. 9/10/11.</p> <p>1 Paar verstellbare Haken aus pulverbeschichtetem Stahl zur Einhängung in Profile (wie z.B. Desk-Up). Zur Verwendung mit Mitesco-Paneelen. Für Mitesco Paneele, Seite 9/10/11.</p>
----------	---------------------------------------------------------------------------	-------------------------------------------------	---------------------------------------------------------------------------------------------------------------------------------------------------------------------------------------------------------------------------------------------------------------------------------------------------------------------------------------------------------------------------------------------------------------------------------------------------------------------------------------------------------------------------------------------------------------------------------------------------------------------------------------------------------------------------------------------------------------------------------------------------------------------------------

3,5 cm

13 cm

1 cm

0,4 cm

0,8 cm

0,2 cm

159/119/75 cm

44 cm

10 - 13 - 16 - 19 cm

1



Descrizione
Description

Pannello con imbottitura interna in poliester a **densità variabile** Snowsound® Technology. Rivestimento esterno in tessuto di poliester Trevira CS®.

Panel with polyester internal padding with Snowsound® Technology **variable density**. Polyester covering in Trevira CS® fabric. .

Panneau avec rembourrage interne en polyester à **densité variable** Snowsound® Technology. Revêtement externe en tissu de polyester Trevira CS®.

Panel con acolchado interior de poliéster de **densidad variable** Snowsound® Technology. Revestimiento exterior de tejido de poliéster Trevira CS®.

Panel mit Polyester-Füllmaterial von **unterschiedlicher Dichte** Snowsound® Technology. Polyester-Bezug aus Trevira CS®-Material.

- 1) Posizionare le staffe cod. 7S111-GA / 7S111-BO / 7S1100-GA / 7S1100-BO
- 1) Position the brackets code 7S111-GA / 7S111-BO / 7S1100-GA / 7S1100-BO
- 1) Posionnez les étriers cod. 7S111-GA / 7S111-BO / 7S1100-GA / 7S1100-BO
- 1) Colocar los soportes cod. 7S111-GA / 7S111-BO / 7S1100-GA / 7S1100-BO
- 1) Positionieren Sie die Halterungen Art. Nr 7S111-GA / 7S111-BO / 7S1100-GA / 7S1100-BO

2 / 3

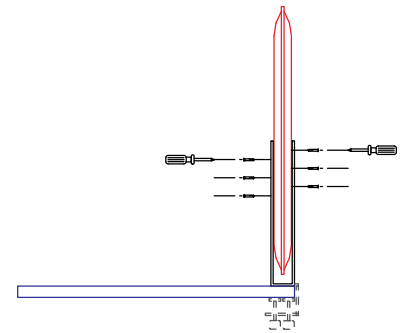

- 2 e 3) Avvitare le staffe cod 7S111-GA / 7S111-BO / 7S1100-GA / 7S1100-BO direttamente al pannello e applicare la copertura in tecnopolimero.
- 2 e 3) Directly screw the brackets code 7S111-GA / 7S111-BO / 7S1100-GA / 7S1100-BO to the panels and put on the hi-tech polymer front cover.
- 2 e 3) Vissez les supports cod 7S111-GA / 7S111-BO / 7S1100-GA / 7S1100-BO directement au panneau et appliquez les couvertures en technopolymere.
- 2 e 3) Atornillar los soportes cod 7S111-GA / 7S111-BO / 7S1100-GA / 7S1100-BO directamente al panel y aplicar las coberturas en tecnopolimero.
- 2 e 3) Schrauben Sie die Halterungen Art. Nr. 7S111-GA / 7S111-BO / 7S1100-GA / 7S1100-BO direkt an das Paneel und befestigen Sie die vordere Abdeckung aus Hi-Tech-Polymer.

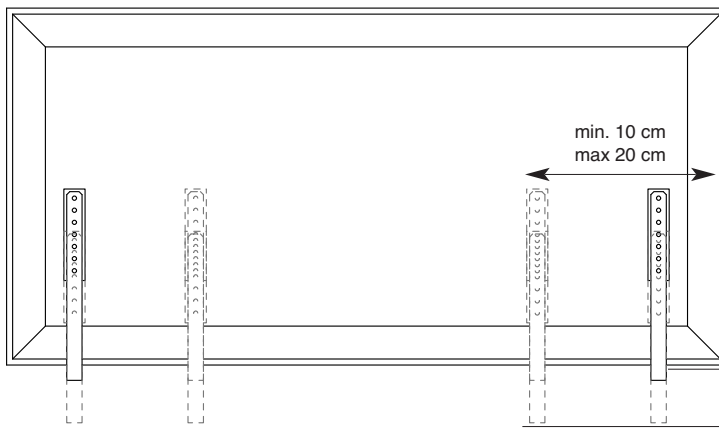

Le staffe possono essere applicate lungo il pannello.
The brackets can be positioned along the panel.
Les supports peuvent être appliqués le long du panneau.
Los soportes pueden ser posicionados a lo largo del panel.
Die Halterungen können beliebig entlang des Paneels angebracht werden.

SNOWDESK

Snowsound® technology by Caimi Brevetti

PER APPLICAZIONI A SCRIVANIA - DESK MOUNTING - MONTAGE SUR LE BUREAU -
MONTAJE SOBRE MESAS DE ESCRITORIO - TISCHBEFESTIGUNG

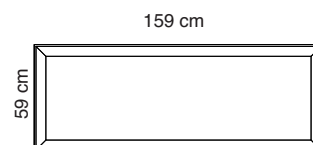
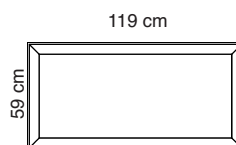
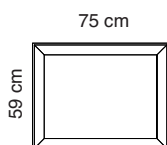
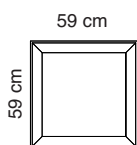

	Codice/Code Prezzo/Price	Codice/Code Prezzo/Price	Codice/Code Prezzo/Price	Codice/Code Prezzo/Price
Bianco White Blanc 0001	7S066-0001	7S086-0001	7S126-0001	7S166-0001
Grigio argento Silver grey Gris argenté 8004	7S066-8004	7S086-8004	7S126-8004	7S166-8004
Grigio scuro Dark grey Gris foncé 8007	7S066-8007	7S086-8007	7S126-8007	7S166-8007
Beige Beige Beige 1008	7S066-1008	7S086-1008	7S126-1008	7S166-1008
Tortora Dove-grey Taupe 2005	7S066-2005	7S086-2005	7S126-2005	7S166-2005
Giallo Yellow Jaune 3008	7S066-3008	7S086-3008	7S126-3008	7S166-3008
Arancione Orange Orange 4030	7S066-4030	7S086-4030	7S126-4030	7S166-4030
Rosso Red Rouge 4027	7S066-4027	7S086-4027	7S126-4027	7S166-4027
Verde chiaro Light green Vert clair 7004	7S066-7004	7S086-7004	7S126-7004	7S166-7004
Verde Green Vert 7013	7S066-7013	7S086-7013	7S126-7013	7S166-7013
Blu Blue Bleu 6071	7S066-6071	7S086-6071	7S126-6071	7S166-6071
Nero Black Noir 8033	7S066-8033	7S086-8033	7S126-8033	7S166-8033

	Codice Code	Colore Colour	Prezzo Price	Descrizione Description
	7S511-GA	Grigio argento Silver grey Gris argenté Gris plata Silbergrau	1 coppia / 1 pair 1 paire / 1 pare 1 Paar	Coppia staffe in acciaio verniciato con polveri epossidiche per fissaggio sopra il piano della scrivania tramite viti (non incluse). Attacchi al pannello Snowdesk e coperture in tecnopolimero grigio o bianco. Per pannelli Snowdesk pag. 65.
	7S511-BO	Bianco opaco Mat white Blanc mat Blanco mate Mattweiß	1 coppia / 1 pair 1 paire / 1 pare 1 Paar	Pair of brackets in powder-coated steel to be fixed on the desk top with screws (not included). Snowdesk Panel connections and front covers in grey or white high-tech polymer. For Snowdesk panels page 65.
				<p>Paire d'étriers en acier peint époxy pour fixation sur le bureau par des vis (pas incluses). Jonctions au panneau Snowdesk et couvertures en technopolymère gris ou blanc. Pour Snowdesk panneaux page 65.</p> <p>Par de abrazaderas de acero recubierto epoxi para fijación sobre el plan del escritorio por medio de tornillos (no incluydos). Enganches al panel Snowdesk y coberturas de polímero gris o blanco. Para Snowdesk panels pag. 65.</p> <p>1 Paar Halterungen aus pulverbeschichtetem Stahl zur Befestigung auf der Tischplatte durch Schrauben (nicht inkludiert). Snowdesk-Paneelbefestigungen und Abdeckungen aus grauem oder weissem Technopolymer. Für Snowdesk Paneele, Seite 65.</p>

	7S100-GA	Grigio argento Silver grey Gris argenté Gris plata Silbergrau	1 coppia / 1 pair 1 paire / 1 pare 1 Paar	Da utilizzare con staffe 7S511-GA / 7S511-BO.
	7S100-BO	Bianco opaco Mat white Blanc mat Blanco mate Mattweiß	1 coppia / 1 pair 1 paire / 1 pare 1 Paar	To be used with brackets 7S511-GA / 7S511-BO.
				<p>Utiliser avec étriers 7S511-GA / 7S511-BO.</p> <p>Utilización con abrazaderas 7S511-GA / 7S511-BO.</p> <p>Zur Verwendung mit den Halterungen 7S511-GA / 7S511-BO.</p>

SNOWDESK

Snowsound® technology by Caimi Brevetti

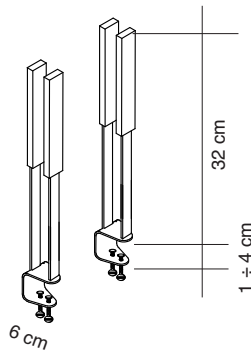

7S1100-GA

Grigio argento
Silver grey
Gris argenté
Gris plata
Silbergrau

1 coppia / 1 pair
1 paire / 1 pare
1 Paar

Coppia staffe con morsetto in acciaio verniciato con polveri epossidiche per fissaggio al piano della scrivania. Attacchi al pannello Snowdesk e coperture in tecnopolimero grigio o bianco. **Per pannelli Snowdesk pag. 65.**

7S1100-BO

Bianco opaco
Mat white
Blanc mat
Blanco mate
Mattweiß

1 coppia / 1 pair
1 paire / 1 pare
1 Paar

Pair of brackets with clamp in powder-coated steel for connection to the desk top.

Snowdesk panel connections and front covers in grey or white high-tech polymer. **For Snowdesk panels page 65.**

Paire d'étriers avec étau en acier peint époxy pour fixation au bureau. Jonctions au panneau Snowdesk et couvertures en technopolymère gris ou blanc. **Pour Snowdesk panneaux page 65.**

Par de abrazaderas con sujetador en acero recubierto epoxi para fijación al plan del escritorio. Enganches al panel Snowdesk y coberturas de polímero gris o blanco. **Para Snowdesk panels pag. 65.**

1 Paar Halterungen aus pulverbeschichtetem Stahl mit Klammern zur Befestigung an der Tischplatte. Snowdesk-Paneelbefestigungen und Abdeckungen aus grauem oder weissem Technopolymer. **Für Snowdesk Paneele, Seite 65.**

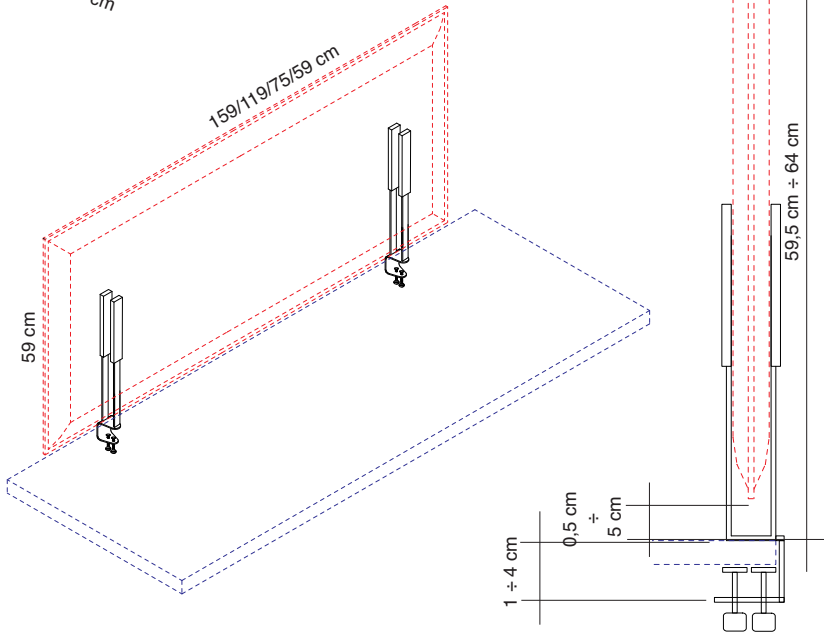

Deze informatie is afkomstig van de website van Zero-Z design.

Voor vragen, toelichting en meer informatie kunt u contact opnemen met:

Zero-Z design

Jasmijnstraat 6a

3732 EC De Bilt

T +31 (0)30 2201297

F +31 (0)30 2210692

E info@zero-z-design.nl

W www.zero-z-design.nl

